

Vol. 8 No. 7/\$2.00

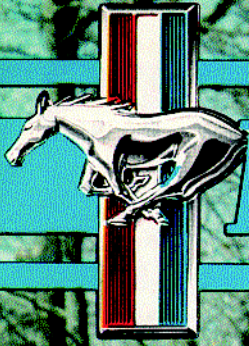

MUSTANG TIMES

July 1984



The Official Publication of

THE MUSTANG CLUB OF AMERICA

**NATIONAL
PARTS
DEPOT**



FLORIDA • CALIFORNIA • MICHIGAN

3 LOCATIONS

LOWER PRICES • FASTER SERVICE • GREATER SELECTION

\$89.95

coupe,
conv &
*fastback



*fold down extra

69-70 Mach I Now Available

FACTORY NEW!

\$109.95

67-72 Front,
67-73 Rear

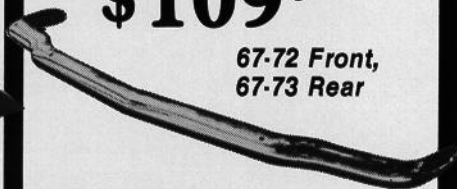

limited time only

Hi-Po 65-71
Air Cleaner

\$19.95



yes—filter is included!

\$39.95 pr.

All colors available

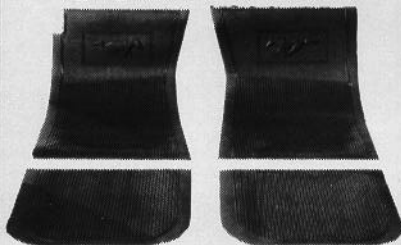

—exact reproductions!

UPHOLSTERY

\$67.95

65-69 std.,
67-68 deluxe



NEXT DAY SHIPMENT!

\$99.00 pr.

65-69



ALL YEARS &
MODELS IN STOCK

\$34.95

65 Std. Gas Cap



\$89.95 set

65-66
non wire
spinners

free
64 page
catalog!

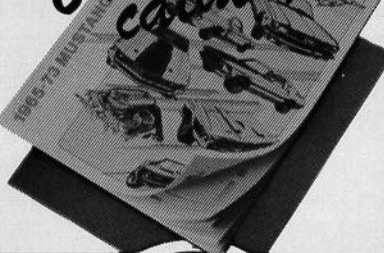

65-66
AM FM
STEREO

CASSETTE DECKS IN STOCK



free
T-shirt
with
\$50. order
While
supplies last



5% shipping charge (\$2.00 minimum).
FREE shipping on orders over \$200.00.
Truck items freight collect. NOTE:
UPS/COD customers—UPS will require
cash or certified payment. Prices listed in this
ad are subject to change without notice.

3101 S.W. 40th Blvd
Gainesville, FL 32608
1495-C Palma Dr.
Ventura, CA 93003
12780 Currie Ct.
Livonia, MI 48150



order
toll
free!

FLORIDA LOCATION

out-of-state 800-874-7595
in-state (toll call) 904-378-2473

CALIFORNIA LOCATION

out-of-state 800-235-3445
in-state 800-342-3614

MICHIGAN LOCATION

out-of-state 800-521-6104
in-state (toll call) 313-591-1956

NATIONAL PARTS DEPOT

FLORIDA • CALIFORNIA • MICHIGAN



MUSTANG TIMES

John



Founded - 1976

FROM
NATIONAL HEADQUARTERS
THE MUSTANG CLUB OF AMERICA, INC.
P.O. BOX 447
LITHONIA, GEORGIA 30058

FOR ADDRESS CHANGES

Please allow at least six weeks for change of address and enclose old address as well as new address, including, if possible, an address label from a recent issue. Send change to address at left.

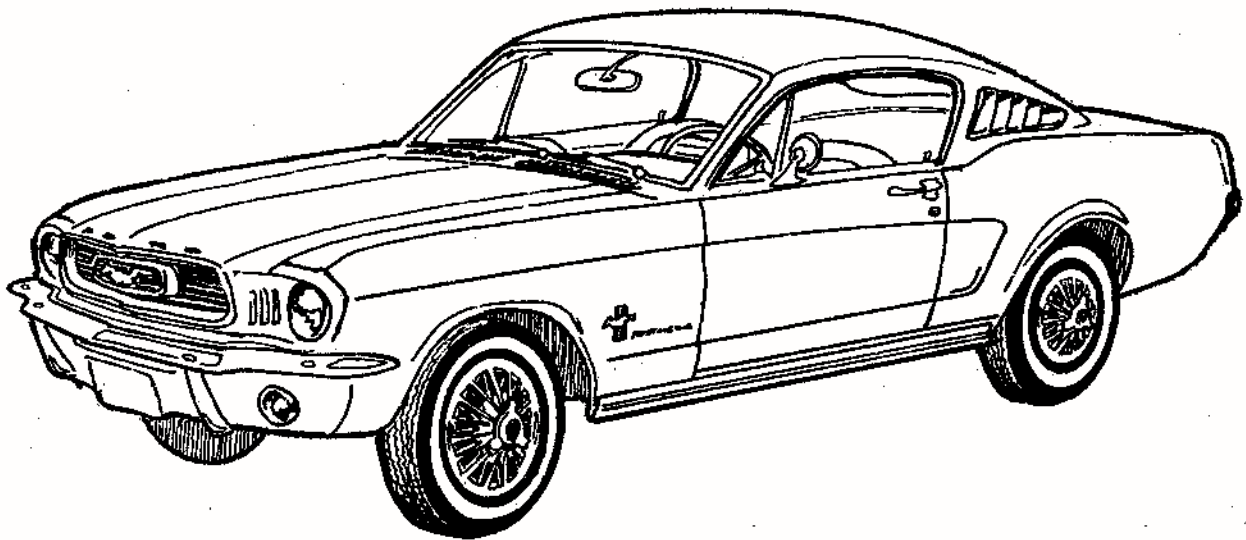

Second Class
Postage
Paid
At Lithonia, Georgia
30058

RUSH TO:

1964½ - 73 Mustangs - Shelbys

... the most exciting American sports cars

NOW THERE'S AN INTERNATIONAL CLUB FOR OWNERS OF THESE SUPERB AUTOMOBILES. WE'D LIKE TO TELL YOU ABOUT IT.

It's called the Mustang Club of America, and you'll find representative members through the United States and Canada ... even in some foreign lands.

Why a Mustang Club?

MCA was formed to band together owners of this classic automobile ... to provide a medium of exchange for ideas, technical information, amusing reminiscences, and the purchase of parts — often at substantial discount. Lasting friendships have been formed through regional get-togethers and as a result of the Club's national meets.

Prized Possession

Mustangs and Shelbys are greatly in demand these days, and a good one is rarely offered for sale because discriminating owners realize they possess an automobile of advanced design and beauty, one that will retain its saucy, modern appearance for years to come with a little loving care. These people have insight and sound judgment, and the Mustang Club of America wants to help them preserve their little cars.

For many such judicious and intelligent folks the savings in time and money in parts location alone have been reason enough for being members of our growing institution. Some dote on tech tips, while for others, the camaraderie that exists between persons of like tastes is their compelling reason for belonging to the Mustang Club of America.

What Membership Means

Whether your Mustang or Shelby serves as everyday transportation, a relaxing plaything, or both, you'll find valuable help in your restoration and maintenance problems in the Tech Tips printed in the club publication, the *MUSTANG TIMES*. This informative, illustrated periodical is distributed every month, and contains many interesting features besides the mechanical information mentioned ... articles

about member cars, news of chapter events and activities, all profusely illustrated with photos, diagrams and cartoons. In addition, the *MUSTANG TIMES* offers an advertising service to those wishing to buy, sell or swap parts or cars.

Tours, meets, rallies, picnics, camp-outs and other outings designed to encourage group participation (with the Mustang or Shelby, that is) are regularly conducted by the various chapter groups located throughout the United States and Canada. There is probably one near you! You are warmly invited to attend any of these friendly chapter meetings or events.

Who Belongs?

MCA boasts people of all ages — from those born before the Turn of the Century to teen-agers still in school. Among the members are professional men and women — doctors, dentists, lawyers — individuals who could certainly afford newer, more costly vehicles if they chose. Widows, widowers, single persons and married all find something of value in their memberships, for the pride of owning the Classic Mustangs and Shelbys, the exclusive personal car of distinction, keeps them driving a vehicle of a past decade. For this company of people, there's a whale of a lot of fun in driving Mustang or Shelby. To them it's a daily holiday, a pick-me-up that never lets them down. It's full expression of their love of life and the chance to live the life they love. MCA wants to keep them feeling that way.

Premium Packet

Every new member receives a new member packet upon payment of initiation fee and dues. Also, many items such as patches, hats, decals, etc. are sold to members only at substantial savings.

MCA Hotline 404-482-4822
Monday - Friday 8 a.m. - 12 noon (E.S.T.)

**OUR OBJECTIVE: EVERY MUSTANG AND SHELBY
OWNER A MCA MEMBER**

APPLICATION BLANK BELOW

For Additional Information, Call This Local MCA Member:

PLEASE ALLOW 6 WEEKS DELIVERY OF FIRST ISSUE

CUT ALONG THIS LINE



Founded 1976

MEMBERSHIP APPLICATION

YES!!! I want to join the most responsive and fastest growing organization in the world dedicated to preservation, care, history and enjoyment of the 1964½-1973 Mustangs — 1965-70 Shelbys. Enclosed \$20.00 U.S. & Canada, (U.S. funds only) \$40.00 foreign (U.S. funds only).

Please send my new member's packet immediately and the next 12 issues of *The Mustang Times*.

NATIONAL HEADQUARTERS • P.O. BOX 447 • LITHONIA, GEORGIA 30058

Name _____

Address _____

City _____ State _____ Zip Code _____

Type of car currently owned _____

OWNERSHIP NOT ESSENTIAL ENTHUSIASM IS

Jack Holland's

AUTO CUSTOM CARPETS

316 "J" Street, Anniston, Alabama 36201 • (205) 236-1118

Mustang

Molded, Original-Style Carpets For Coupes, Convertibles, Fastbacks and Fastbacks with Fold-downs.

We **GUARANTEE** that you've never seen Mustang Carpets that will compare to ours!

1964½-1968 Series:

Nylon loop and cut pile for coupes, convertibles and fastbacks SET **\$95**

Original-style 80/20 Rayon/Nylon loop SET **\$105**

Fold-down package for fastbacks EACH **\$15**

Kick-pad carpets for coupes and convertibles SET **\$14⁹⁵**

NOTE: Mustang heel pads are produced from plastisol compound in original Mustang molds and are as close to 100-point as can be made.

1969-1970 Series:

Nylon loop for coupes, convertibles and fastbacks SET **\$95**

Fold-down package for Fastbacks EACH **\$15**

Mach-I Deluxe with full insert package SET **\$160**

1971-1973 Series:

Nylon loop for Coupes or Fastbacks SET **\$95**

Fold-down package for Fastbacks EACH **\$15**

NEW! 1971-1973 Mustang Convertible Carpets . . .

These molded carpet sets are an actual "re-run" of the original carpets. Available in nylon loop material in all of the original colors.

SET **\$95**

• OEM quality, fit and appearance • All carpets molded and trimmed to fit just like the originals • Easy installation-perfect results every time.

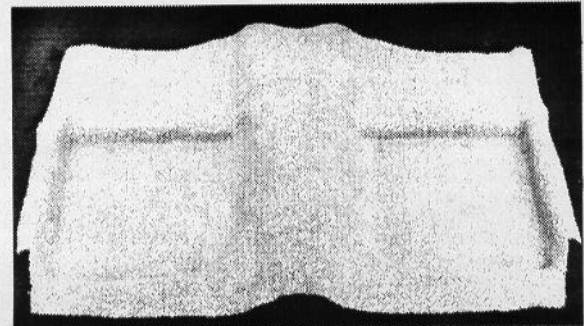
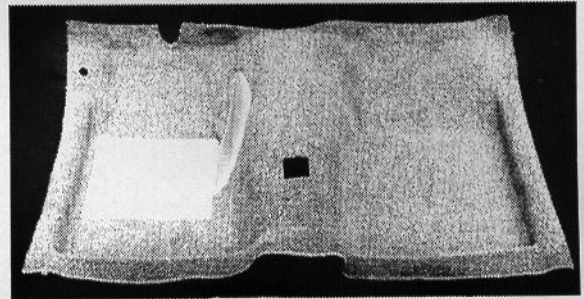

Coupes and Convertibles

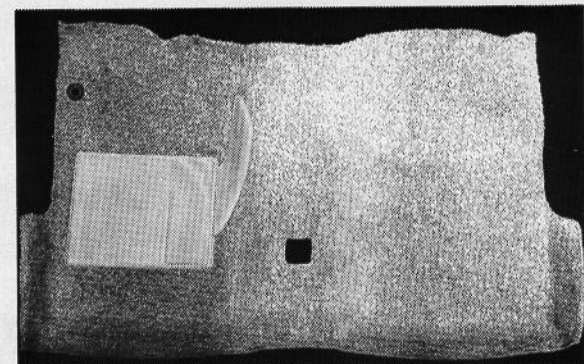

Fastbacks



OUR TOLL FREE ORDER NUMBER . . . **1-800-633-2358**

For more information or for calls within Alabama . . . **(205) 236-1118**

We Ship UPS/C.O.D. Anywhere In The Continental United States

We Gladly Accept . . .



THE FORD PARTS WAREHOUSE

PARTS & ACCESSORIES

1965 Full wheel cover, 13" or 14"	ea. \$ 20.00
1966 Full wheel cover	ea. 22.50
Spinner & blue center for 1965-66 wire wheel cover	ea. 24.50
1966 Trim ring for styled steel wheels	24.50
1965-66 Red center for styled steel wheels	17.00
1965-67 Lug nuts for styled steel wheels	ea. 3.00
1967 Trim ring for styled steel wheels	24.50
1967 Blue center for styled steel wheels	10.00
1967 Full wheel cover	20.00
1968 Full wheel cover (plain center)	26.00
1968 Full wheel cover (red center)	42.00
1968 Trim ring for styled steel wheels	24.50
1966 Chrome Hi-Po air cleaner	22.50
1965-66 GT exhaust trumpets	pr. 125.00
1965-66 Chrome trim for GT trumpets	ea. 14.00
1965-68 GT or std. rear valance, specify yr.	49.50
1965-66 Front bumper	120.00
1965-66 Rear bumper	120.00
1967-68 Front bumper	110.00
1967-68 Rear bumper	110.00
1965-68 Bumper guards (set of 4)	73.00
1965-68 Front valance, specify year	61.75
1965-66 Rocker panel molding	ea. 54.00
1967-68 Rocker panel molding	ea. 30.00
1965 Quarter panel ornament	16.75
1966 Quarter panel ornament	18.50
1965-66 Outside door handles	ea. 16.65
1967-68 Outside door handles	ea. 18.75
1965-66 Tail lamp bezels	ea. 14.75
1967-68 Tail lamp bezels	ea. 11.0
1965 Grille mesh, specify std. or GT	54.75
1966 Grille	80.50
1967 Grille	67.00
1965-67 GT grille bars, specify year	pr. 135.00
1965-67 Fog light assemblies	ea. 61.60
1965 Grille ornament "Horse and Corral"	58.00
1965 Grille bars, std.	ea. 22.00
1965-66 Fenders, specify year, side	ea. 175.00
1965-68 Coupe quarter panels, specify yr.	190.00
1965-68 Convertible quarter panel	190.00
1965-66 Fastback quarter panel	475.00
1965-66 Dash bezel, specify yr. & type	31.25
1967 Dash bezel, black	26.45
1967 Dash bezel, brushed alum.	46.95
1968 Dash bezel, black	46.95
1968 Dash bezel, woodgrain	46.95
1965 Dash pads (black, red, blue)	120.00
1966 Dash pads (black, burgundy, blue)	120.00
1965-66 Armrest pads, specify yr., color	ea. 18.00
1965-66 Chrome armrest bases	ea. 14.00
1967-68 Armrest pads, specify yr., color	ea. 25.00
1965-68 Fuel tank	90.00
1965-66 Trunk mats, specify year, body type	41.50
1965-68 Steering wheel, black	78.00
1965-66 Horn ring for std. wheel	56.00
1965-67 Horn ring for woodgrain wheel	25.00
1965-68 Parking lamp assembly	30.00
1967-68 Parking lamp assembly	30.00
1965-66 Back-up lamp assy, specify year	37.50
1965-66 Ign door lock set w/2 pony keys	28.50
1965-68 Step plates (specify body type)	pr. 28.00
1965-68 Accessory step lates (outer)	pr. 46.00
Cobra alum. valve covers, 260-302	pr. 75.00
Cobra alum. valve covers, 351-428	pr. 110.00
1965-66 Hood	225.00
1967-68 Hood (specify year)	215.00
1965-66 Radiator (specify engine)	175.00
1965-68 Luggage rack (except fastback)	130.00
1967 Antenna kit	60.00
1965-66 Door edge guard kits	25.00
1967-68 Parking lamp assy.	27.60

REPAIR PANELS

1965-66 Lower rear corner patch panel 7 1/2" height	25.00
1965-70 Lower rear corner patch panel, 12" height, specify year	33.00
1965-70 Rear wheel flair, specify year	33.00
1965-70 Rear frame rail	51.00
1965-66 Lower rear corner of front fender	25.00
1967-68 Lower rear corner of front fender	26.00
1965-70 Inner panel, lower rear qtr.	21.00
1965-68 Short frt. floor pan	per side 44.00
1965-68 Long frt. floor pan	per side 49.00
1965-68 Rear floor	per side 49.00
1965-70 Inner rear wheel Hsg.	50.00
1965-68 Outer wheel Hsg. specify year	59.00
1965-68 Conv. inner rocker panels	65.00
1965-68 Conv. torque boxes	66.00

UPHOLSTERY 1965-68

(Specify Year and Color)

Complete set std. interior	185.00
Front buckets only	pr. 132.00
Complete set with bench front	225.00
Complete set 65-66 "Pony" interior	270.00
Front buckets only	190.00
Door panels std. interior	52.00
"Pony" door skins	135.00

MOLDED CARPET

All carpets molded and trimmed to fit your car just like the original. No cutting or fitting required.
Coupes, convertibles, fastbacks, without fold down area 95.00
Fastbacks with fold down area 115.00

ACCESSORY PONY MATS

Complete, set of four	45.00
Fronts only	30.00
SHOP MANUALS, LITERATURE, PARTS CATALOGS	
'65-'68, '70-'73 Shop manuals	25.00
'65-'73 Owners manuals	6.00
Mustang Does It	27.50
'65-'72 Genuine Ford parts catalogs, loose leaf, gives illustrations and part numbers	60.00
1965-70 Factory Facts books, specify year	4.95

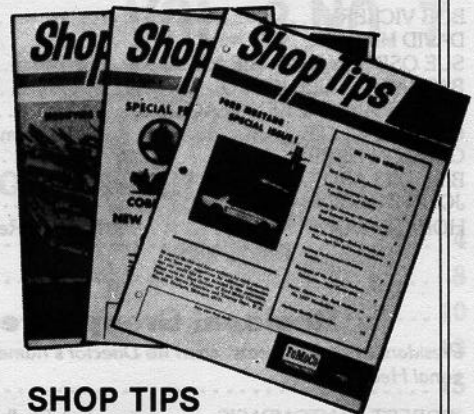

SHOP TIPS

Ford Parts Warehouse has reprinted 3 of Ford's Mustang-related SHOP TIPS publications. Volume 2, Number 4 is the special Mustang issue that introduced Mustang specifications to Ford service dealers. Volume 2, Number 2 (February 1964) describes the "Cobra Kits", and Volume 2, Number 6 includes a section on "Modifying Ford V-8s for High Performance". The superior quality reprints sell for \$4.50 each, PPD.

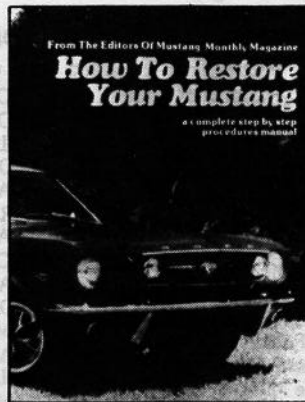

HOW TO RESTORE YOUR MUSTANG

1965-68 Covers each phase of restoration in detail 14.95



MUSTANG RECOGNITION GUIDE

Compiled by the editors of Mustang Monthly, over 300 photos in color . . . 16.95

We also have a huge inventory of obsolete Ford Parts if you don't see it listed call or write (SASE) for availability and price. Send \$2.00 for our 72 page catalog of Ford and Mustang Parts. All parts are new unless noted. Please add 10% (\$2 minimum) for UPS except fenders, hoods and quarter panels will be shipped freight collect.

MasterCard and VISA accepted. Satisfaction guaranteed (30-day return)

FORD PARTS WAREHOUSE

Courthouse Square, Liberty, Ky. 42539

PH: 606-787-5031

CLUB OFFICERS

1984 National Officers

BOB VICKERY	President
DAVID HICKS	Vice President
SUE OSBORN & JACKIE MILLS	Co-Secretaries
BARBARA & BILL KOIVU	Co-Treasurers
A. W. AMANNS & KEN YEAGER	Sergeant-at-Arms
GEORGE WHITE	Chairman, Board of Directors
GORDON HARRISON	Parliamentarian
BILL DILLARD	National Head Judge
JOHN ROGERS	Magazine Publisher
HORACE WOOD	National Regional Group Director

Regional Group Directors

President's name appears when no Director's name has been sent to National Headquarters.

ROBERT CANTOMPASIS	Adirondack Shelby-Mustang Region, Inc. SAAC-MCA
WAYNE RUDD	Alberta Mustangs
RANDAL J. LANDRY	Ark-La-Tex Pony Express
LANITA BRAUD	Baton Rouge Mustangers
JERRY CATON	Bluegrass Mustang Club
JOHN ALDRIDGE	Birmingham Mustang Club
ALAN RAMSAY	Bi-City Regional Group
PERRY RIVERS	Carolina Region Mustang Club
KEN DANIEL	Central Florida Regional Mustang Club
BOB DOBRINICK	Central Illinois Regional Chapter
ROBERT STUART	Central Jersey Mustangs
CRAIG ZOIN	Central South Carolina Regional Group
TONY BRANDA	Centre Region Mustang Club
NELSON FOWLER	Coal Country Mustang Club
JOHN D'AMBROSIO	Copper State Mustang Club
RAY WHITLEY	Eastern North Carolina Regional Group
FRED GLAZIER, JR.	First Pennsylvania Regional Group
HAROLD GOAD	First Piedmont Regional Group
BILL HENDERSON	First Tennessee Regional Group
DARYL WAGNER	Flood City Mustang Club
LARRY HURST	Ft. Lauderdale Mustang Club
JIM PAYNE	The Foothills Regional Group
BOB SUMMERS	Gate City Triad Club
GORDON HARRISON	Georgia Regional Group
BOB ASCOTA	Gold Coast Mustang Club
G. W. McNUTT	Golden Circle Mustang Club
SCOTT McNAIR	Golden Hills Mustang Club
GARY HENDRIX	Gulf Coast Regional Group
JOHN HEMBREE	Hall of Fame Mustangers
ROBERT E. MESSICK	Heart of Dixie Mustang Club
TONY LAGONE	Hernando County Mustang Assn.
STEVE BILDERAIN	Highway Horsemen of Southern California
DON LAWLESS	Hoosier Mustang Club
KERT MAUL	Kansas City Mustang Club
CHARLES CROSS	Lakeway Mustang Club
MONTY SHEHORN	Mid-America Regional Group
TOM HOYT	Mid-Missouri Mustangs
KEITH DERN	Mississippi Coast Stangers
EDDIE FORD	Model City Mustang Club of America
BOB OVERBY	Music City Regional Group
BILL LEWIS	Mustangs of Buffalo
RON MILLER	Mustang Car Club of Omaha, Inc.
PHIL SMITHEY	Mustang Club of Las Vegas
GENE SCHWANDTNER	Mustang Club of Maryland
BOB KASPRZAK	Michiana Mustangs
DON GILLESPIE	Mustang Owners' Club of SE Michigan
CHARLES YOUNG	Mustangs of Memphis
HOWARD LEE NICHOLS	Mustelby Mustang Club

RICH BORER	Northeast Nebraska Mustang Club
ARTHUR DICE	Northeast Pennsylvania Regional Group
JIM WATSON	Northeastern Ohio Regional Group
LARRY GRASER	Northwest Ohio Regional Group
DENNIS STANFORD	Northern Valley Mustang Club
JOHN K. GRIFFITH, JR.	North Jersey Mustangs
RON CLEMENTS	North Texas Mustang Club
ROBERT HALTERMAN	Old Dominion Mustang Club
NOAH YODER	Old Fort Mustangs
SCOTT SEITZ	Pony Express River City Mustangs
TOM ANDERSON	Rio Grande Mustang Club
BILL NEWTON	Rocket City Mustang Club
BILLY CRAIG	Sandhills Regional Group
LARRY EATON	Scenic City Regional Group
LEONARD FOLTZ	Shenandoah Valley Mustang Club
JOHNNY BISHOP	Shoals Mustang Club
RICH RILEY	South Jersey Mustangs
O. SCHWALLENSTECKER	Southern Illinois Mustang Assn.
JOYCE FUDGE	Texas Classic Mustangs
TERRY HAWTHORNE	Texas Panhandle Mustang Club
JILL SMETHERS	The First State Mustang Club
MIKE FLANDERS	Three Rivers Regional Group
MIKE OWEN	Treasure Coast Mustang Club
KEVIN McATEE	Treasure State Mustang Club
BILL SULLIVAN	Tri State Mustangs
HOWARD STEINER	Twin Tier Regional Group
WARREN PERKINS, SR.	Valley Forge Mustang Club
DOUG OWEN	Volunteer Regional Group
LARRY E. FINCHER	West Georgia Regional Group
CARL BRUNER	Wiregrass Regional Group
DICK COYLE	The Wisconsin Early Mustangers

1984 National Board of Directors

(1/85)	A. W. AMANNS	Fairburn, GA
	DONALD CHANDLER	Woodstock, GA
	RON DAVID	Atlanta, GA
	BILL DILLARD	Calhoun, GA
	TOM GATTIS	Conyers, GA
	GARY GODDARD	Lithonia, GA
	TRACEY HARRELL	Lilburn, GA
	GARY HARTTER	Marietta, GA
	GORDON HARRISON	Doraville, GA
	DAVID HICKS	Roswell, GA
	ED HUNTER	Powder Springs, GA
	JIM HUNTER	Powder Springs, GA
	BARBARA KOIVU	Stone Mountain, GA
	BILL KOIVU	Stone Mountain, GA
	JACKIE MILLS	Morrow, GA
	JIM OSBORN	Lilburn, GA
	SUE OSBORN	Lilburn, GA
	MARY PARKS	Snellville, GA
	MEL PARKS	Snellville, GA
	BERLIN PLESS	Roswell, GA
	MARJORIE PLESS	Roswell, GA
	JOHN ROGERS	Redan, GA
	JANE SINGLETON	Decatur, GA
	BOB VICKERY	Lithonia, GA
	TERESA VICKERY	Lithonia, GA
	BOBBIE WHITE	Smyrna, GA
	BRENDA WILSON	Lithonia, GA
	EVELYN WOOD	Birmingham, AL
	HORACE WOOD	Birmingham, AL
	JACK YEAGER	Decatur, GA
	KEN YEAGER	Decatur, GA
(10/85)	GEORGE WHITE	Smyrna, GA

MUSTANG TIMES

The Official Publication of the Mustang Club of America

JULY 1984

VOL. 8 NO. 7

Publisher
John Rogers

Editor
Bob Vickery

Assistant Editors
Teresa Vickery
Brenda Wilson

Typography
Custom Composition
Stone Mountain, Georgia

Printing
DeKalb Litho
Avondale Estates, Georgia

Fulfillment
Mustang Classic Collections, Inc.
Pine Lake, Georgia

National Head Judge
Bill Dillard
Route 4
Calhoun, Georgia 30701

National Regional Group Director
Horace A. Wood
3653 Altadena Drive
Birmingham, Alabama 35243
(205) 967-1705

Ad Manager
Teresa Vickery
1470 Stephenson Road
Lithonia, Georgia 30058
(404) 482-7044
Mon. & Tues. 10-12 a.m.

Office Manager
Brenda Wilson
(404) 482-4822

TABLE OF CONTENTS

Club Officers	4
President's Column	8
Event Calendar	10
Ragoon Red Convertible	13
Ask Fred	15
Mistress	16
Cover Car	20
Ford's Boss	28
Memphis Show	32
New Products	38
Regional Group News	40
Classifieds	43
MCA Accessories	47
Regional Group Listing	48
Advertisers Index	50



For any correspondence pertaining to new membership, club information, renewals, national club business, or the *Mustang Times*, please send your letter to National Headquarters address:

The Mustang Club of America, Inc.
P.O. Box 447
Lithonia, GA 30058

OR

Phone National Headquarters
at: (404) 482-4822
8 - 12 Noon Monday thru Friday
(no collect calls, please)

Mustang Times (ISSN 0744-2572) is published monthly by the Mustang Club of America, Inc., 1470 Stephenson Road, Lithonia, Georgia 30058. Membership dues to the club are \$20 per year which includes \$15 for twelve monthly issues of *Mustang Times*. Second class postage paid at Lithonia, Georgia 30058. Postmaster: please send address changes to *Mustang Times*, P.O. Box 447, Lithonia, Georgia 30058.

It is requested that any transaction with the club, including dues payment, be made by check or money order made payable to the Mustang Club of

America. Cash must be sent at your own risk. Please notify the club of any change of address immediately and allow a minimum of six weeks.

Mustang Times and The Mustang Club of America do not accept any responsibility for the accuracy of advertisements and/or advertisers. Any advertisers who have proved unreliable or who have been named in legitimate complaints from MCA members will not be allowed to advertise. Liability for clerical and/or typographical errors which may appear in *Mustang Times* is limited to the correction of same.

Mustang Magic

Tom Sullivan

BOX 1034

WHITE RIVER JUNCTION, VT 05001

802-295-7231

NEW FROM MUSTANG MAGIC

Mustang Magic is offering a choice in Mustang Steering Wheel restoration processes.

Sulco Woodgrain Wheels — 65-67. For those who want a restored 65-67 Woodgrain Mustang Wheel that is stronger and more durable than the original, we offer our new Sulco Process.

The Sulco Process involves custom fitting your original wheel with a new upper and lower casting, resulting in a beautiful duplicate woodgrain wheel, guaranteed never to crack or separate again, under the normal use.

Processing time involved in restoring the wheel is drastically cut. Sulco Wheels are available for immediate shipment.

Complete Sulco Woodgrain Wheel (includes plating process)	\$250.00
	210.00 EXCHANGE
Sulco Process of Wheel only	125.00
Plating of the Wheel	45.00

STEERING WHEEL PRICE LIST

64½-67	All Colors	\$ 65.00
	All cracks filled, wheel colored and sealed to original trim code.	
65-67	Stock wheels available in all colors	85.00
67	Center Pad	24.00
65-67	Deluxe Woodgrain	75.00
	Wheels filled, dyed, woodgrain effect restored, wheel sealed, chrome dots N/C.	
65-67	COMPLETE WOODGRAIN WHEEL THAT LOOKS LIKE NEW!	195.00
		150.00 EXCHANGE
	Wheels filled, dyed, plated, woodgrain restored and wheel sealed	125.00
		95.00 EXCHANGE

	PLATED EXCHANGE	NEW
HORN RING	\$20.00	\$25.00
CAP	\$20.00	\$55.00
RING SPACER	\$10.00	\$20.00

Cap and Ring Spacer are beautiful plastic duplicates.

68-70	Complete woodgrain wheels restored	135.00 EXCHANGE
69-73	Regular wheel restoration, wheel only	85.00
70-73	Woodgrain Wheel N.O.S.	210.00
		185.00 EXCHANGE
70	Standard N.O.S.	85.00

We also stock many wheels and parts for 65-73 Mustang Wheels.

SERVICE AVAILABLE FOR 65-67 ORIGINAL SHELBY WOOD WHEELS.

For additional free information on parts and wheels not listed, please feel free to write or call.

PRICES ARE SUBJECT TO CHANGE.

one good brake deserves another

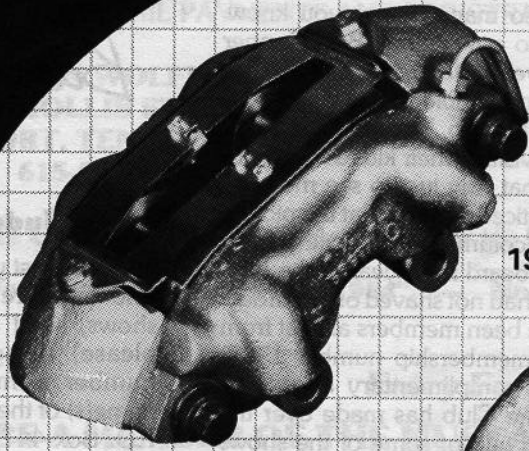

1968 — '73 Mustang

1964½ — '67 Mustang*

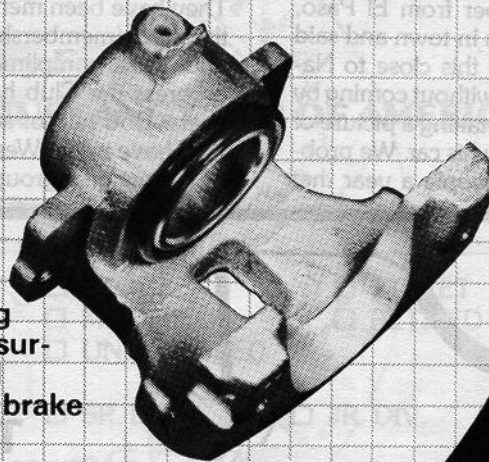

Introducing our Stainless Steel Single Piston Floating Caliper. Hardened sliding surfaces and a stainless steel piston will assure equal brake pad wear forever.

* Reservations now being accepted for 1965-1967 drum to disc brake conversion kits. Available for spring 1984 delivery.



**STAINLESS STEEL
BRAKES CORP.**

© Stainless Steel Brakes Corp. 1984

Call Toll Free 800-448-7722
In N.Y. (716) 759-8666

STAINLESS STEEL BRAKES CORP.
11470 Main Road / Clarence, N.Y. 14031

Please send me more information about your stainless steel brake system products for Mustang, Shelby and T-Bird.

1964½ - '67 1968 - '73

Name _____

Address _____

City _____

State _____ Zip Code _____

MT-3

PRESIDENT'S COLUMN

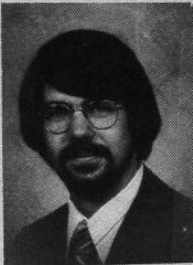

Being President of the Mustang Club I have the pleasure of corresponding with many of our fine members from across the country. I attend all the National shows and get to meet more fellow Mustangers there also. I don't know how many of you realize that National Headquarters is actually a 8 x 6 inch post office box. The Club phone is in an office at the Wilson's residence and I work out of an office at my home as does all our other officers that correspond with the general membership.

I am relating all of this for a particular reason. Last Saturday while I was at work, a Club member from El Paso, Texas called and was in town and said he just could not be this close to National Headquarters without coming by and meeting me and taking a picture of myself and Teresa by his car. We probably don't get two people a year that

have any real interest in coming by but these people were very enthusiastic and even compared meeting the President of the Mustang Club with seeing President Reagan. Most of the time I am at a disadvantage when meeting any of our Mustang friends because you know more about me than I know about you. My poor old mind only remembers so many names you know. But back to our visitors; Bob Conner and his lovely wife drove their 1964½ Mustang convertible all the way to Atlanta from El Paso, Texas. I must admit they were visiting their kids and did not come all that way just to see me.

They noticed right off that the picture above this column is a little old (I have not had a beard for a year and a half) although I had not shaved on Saturday. They have been members almost from the start (membership number 1391) and were complimentary about the progress the Club has made over the years. Bob told of some of the shows they have in the West and about some of the regional groups they have dealt

with. We talked for a while, looked over his '64½, took pictures, uncovered Teresa's 1972 and showed it off a little and they drove off headed next for Murphy, North Carolina.

I think the Conner's represent the type of members we have in the Club — ENTHUSIASTIC!

Judging Sheets

To request your judging sheets from one or more of the 1984 National shows, send a SASE (20¢ postage, please) along with your car entry number from the show(s) and the name(s) of the show attended to MCA, P.O. Box 447, Lithonia, GA 30058.

Please allow 3 to 4 weeks for processing.



Announcing The Mustang Club of America 1984 Membership Drive

Beginning in May any member who signs up a new member on the application form on the inside cover of the *Mustang Times* with the mailing label on the reverse side will receive a free "A Legend Turns Twenty" T-shirt. These T-shirts will be available only through the membership drive campaign. You can earn as many shirts as you want so get started recruiting new members today!

(Be sure to indicate the size shirt required (small, medium, large, or ex-large) next to your mailing label on the reverse side of the application form.)

Shelby Vaughan
Rt. 2 Belton
Luffin Rd
8A

Mustang Club of America's 20th Anniversary Grand National Kingsport '84

CHARLES
822 SHARON
TIP
9-10-11

Hosted by the First Tennessee Regional Group, M.C.A.
August 10, 11, & 12, 1984

Headquarters: Ramada Inn, Kingsport, Tennessee. For room reservations phone 615-245-0271. Rates are \$48.00 per night. Be sure to state that you are a member of MCA.

FOR ADDITIONAL INFORMATION CONTACT SHOW COCHAIRMEN:
ALSO MAIL PAYMENTS AND REGISTRATIONS TO:

DON WOLFE
637 HOLLIS STREET
KINGSPORT, TENNESSEE 37660
615-247-4292

GARY CHILDRESS
5120 WOODSWAY
KINGSPORT, TENNESSEE 37664
615-288-4498

Make Check or Money Order Payable to: First Tennessee Regional Group

Deadline to register cars "August 1, 1984" — No car registrations accepted at the show!!!

Entry Form

YOU MUST BE A MEMBER OF THE MUSTANG CLUB OF AMERICA TO ENTER

Name _____ Membership No. _____ Exp. Date _____

Address _____ City _____ State _____ Zip _____

Year _____ Body Style _____ Serial No. _____ STOCK STREET \$5.00

Year _____ Body Style _____ Serial No. _____ MODIFIED RETIRED

UNRESTORED SR. DIV. JR. DIV.

PONY CORRAL — \$15.00 EACH

Registrations received by August 1, 1984, will receive free T-shirt. Size _____
Swap Meet Spaces (10 x 20) \$30.00 each space — Number needed _____ \$ _____

— Only Mustang, Shelby, Boss & Ford-Related Parts —

Raffle tickets for '65 Fastback at \$1.00 each — Number needed _____ \$ _____

Drawing: Saturday, August 11, 1984, 4 p.m., Show Site (Proceeds to charity)

What classes are you certified to judge? _____

Will you judge: Yes? _____ No? _____

AWARDS BANQUET RESERVATIONS

Saturday, August 11, 1984 — 7 p.m.	Adults \$14.00 Each	\$ _____
Ramada Inn, Kingsport, Tennessee	Children 10 and Under	\$ _____
	\$6.00 Each	

I agree to abide by all rules and regulations of the Mustang Club of America and understand that I am responsible for my automobile and merchandise. I agree to release all liability from Mustang Club of America, First Tennessee Regional Group, Ramada Inn (and associated personnel) for any damage, injury, lost, or stolen merchandise from this event. I also agree to leave my car or vendor space stationary.

Signature: _____ Date: _____

For Additional Information Call: **President - Ernie Stout, 615-349-7762**

EVENT CALENDAR

- July 6-8 Dixie National, Birmingham, AL. Hosted by the Birmingham Mustang Club. For information contact Bob Wood (205) 956-0192 or Bill Rodgers (205) 744-9922.
- July 8 4th Annual Mustang — Ford Car Show. Huston Ford. Hosted by the Centre Region Mustang Club. 2 miles East of Huntingdon, PA. Indoor/outdoor Flea Market spaces available. \$3 per car pre-registration; \$5 day of show. For more information contact Mike Beaver (814) 643-1243 or David Runkle (814) 355-2270.
- July 13-15 Fourth Annual Music City International Mustang Roundup, Crown Ford, Nashville, TN. Hosted by the Music City Mustang Club. For more information contact Gary Alsobrook (615) 262-5757 days, Connie Gately (615) 754-5770 days/nights and Mike Whitley (615) 758-8930 nights.
- July 14 Roundup '84, Magic City Ford, VA. Hosted by the Mustelby Mustang Club. Rain date July 21. For more information contact Richard Graham (703) 362-0502 or Howard Nichols (703) 721-3761.
- July 15 6th Annual Car Show and Flea Market, Washington, DC. Show location to be announced. For information contact Fred Richmond (703) 323-9642 evenings or Paul Jordan (703) 476-0135 evenings.
- July 15 2nd Annual Eastern Pennsylvania SAAC Mustang-Shelby Ford Show. McCafferty Ford, Route 1 and Woodbourne Rd., Langhorne, PA. Judged MCA classes. Hosted by the Pennsylvania Shelby American Auto Club. For information contact Joe Manduke (215) 345-7342.
- July 20-22 National Convention and Show, Great Bend, Kansas. Hosted by the Shelby Owners of America, Inc. Drag Races — Auto Cross — Car Show. For more information contact Randy Schwartz, RR 4, Box 179A, Great Bend, KS 67530.
- July 21 7th Annual Mustang Round-up and Swap Meet, Roberts Ford, Alton, IL sponsored by the Southern Illinois Mustang Association and Roberts Ford. All 65-73 Mustangs and Shelybs welcome. Entry fee only \$7. Rain date July 22, 1984. For more information send large SASE to Harry N. Kulp, 214 Chelsea Ln., Brighton, IL 62012 or call (618) 372-8488 or 465-2482.
- July 22 2nd Annual Mustang and Shelby Auto Show and Swap Meet, Lindale Mall, Cedar Rapids, IA. Hosted by the Eastern Iowa Mustangs. Overnight accommodations and security. For more information contact Bob Reihman (313) 628-4332 or Dave Sargent (319) 842-2459.
- July 22 1st Annual All Ford Car Show. Jim McKain Ford, Route 19, Wexford, PA. Hosted by the Three Rivers Regional Group. For more information contact Donna Penkova, 4803 Bert Dr., Monroeville, PA 15146 (412) 856-8923.
- August 3-5 Super Run '84, Washoe Country Rancho San Rafael Park, Reno, Nevada. Ford more information contact the Super Run, Inc., 2901 S. Highland Dr., #12, Las Vegas, NV 89109, (702) 369-2855.
- August 10-12 4th Annual Street Machine Nationals, Utica, MI. Ford Proving Grounds off Van Dyke Avenue. Hosted by the Super Ford Magazine. For more information contact Super Ford Magazine, P.O. Box 359, 172 Fall St., Seneca Falls, NY 13148 or call (315) 568-2011.
- August 12 1st Annual Detroit Performance Cars and Swap Meet, Zollner Stadium, Ft. Wayne, IN. For more information contact Rainbow City, 1418 Broadway, Ft. Wayne, IN 46802 or (219) 442-7790.
- August 10-12 1984 Grand National, Kingsport, TN. Hosted by the First Tennessee Regional Group. For information contact Gary Childress (615) 288-4498 or Don Wolfe (615) 247-4292.
- August 12 4th Annual Car Show, Wahoo, NE. Hosted by the Saunders County Auto Association. For information contact Tim Bern, 525 N. Walnut, Wahoo, NE 68066 (402) 433-3155, or Alan Tast, Route 1, Box 102, Yutan, NE 68073 (402) 625-2321.
- August 19 Coopersburg, PA Car Show and Flea Market, Saucon Valley Living Memorial Park. Hosted by the First Pennsylvania Mustang Club. For more information contact Ken Floyd, 430 Kalmia St., Warminster, PA 18974 (215) 672-0434.
- Aug. 31-Sept. 2 Rio Grande Regional '84, Albuquerque, NM. Hosted by the Rio Grande Regional Group. For more information write Rio Grande Mustang Club, 9716 Trumbull, SE, Albuquerque, NM 87123.

- September 7-9 Adirondack Northeast Nationals, Lake George, NY. Hosted by the Adirondack Shelby-Mustang Regional Club. For more information write Adirondack Shelby-Mustang Regional Club, P.O. Box 107, Burnt Hills, NY 12027 or call Steven (518) 869-7979, John (518) 885-9013, Debbie (518) 861-7270 or Jamie (518) 372-4083.
- September 8-9 1st Annual Raccoon Mountain "All Ford" Show, Raccoon Mountain Camping Grounds, Alpine Slide, 4328 Cummings Highway, Chattanooga, TN. Hosted by the Scenic City Regional Mustang Club of America. For information contact Roy Willhoit, (615) 867-1243, Jim Johnson (615) 894-2068, or Junior Downer (615) 842-4293.
- September 8-9 4th Annual Mustang-Shelby Ford Car Show and Swap Meet, Travel Lodge/Viscount Hotel, NJ Turnpike Exit #4 at Rt. 73. Hosted by the South Jersey Regional Mustang Club. For more information contact S.J.R.M.C., 681 N. Mill Rd., Vineland, NJ 08360 or call Rich Riley (609) 696-8643 or Joe Rementer (609) 589-5409.
- September 14-16 Fall National, Columbia, SC. Hosted by the Central South Carolina Regional Group. For information contact Craig Zoin, P.O. Box 2614, Columbia, SC 29209 (803) 533-1410 day or 791-3149 night.
- September 23 "Meganood '84," Folsom between 7th and 11th St. Hosted by the Folsom Street Fair. Showcasing classic cars with works of art for the first time. For more information send SASE to Classics, 74 Langton St., San Francisco, CA 94103.
- September 29 3rd Annual Car Show and Swap Meet, Mitchell-Howell Ford, Martinsville, VA. Hosted by the First Piedmont Regional Group. Rain date October 6. For more information call (703) 694-4232 or 694-4456.
- October 7 3rd Annual Fall Auto Parts Swap Meet, Youth Center Building, Monticello, IA. All vendor reservations must be made in advance. For more information contact Ralph or Galen Muller, 853 Southhaven Drive, Monticello, IA 53210. (319) 465-5119 or (319) 465-5380.
- October 13 Mustang Rally and Swap Meet, Parkway Ford, Winston-Salem, NC. Hosted by the First Piedmont Regional Mustang Club. Rain date October 20. For more information call (703) 694-4232 or (919) 724-5921.
- October 26-29 17th Annual "Great Pumpkin" Car Show. Hosted by the Southern Arizona Mustang Club. For more information contact Mrs. Cathy Wren, 2025 Heatherbrae Circle, Tucson, AZ 85715 (602) 885-0963.

YESTERDAYS CARS BUILT FOR YOU TODAY BY

Gelsi's Mustang World

COMPLETE AUTO RESTORATION

Any Make, Any Model

SPECIALIZING IN: 64½-73 MUSTANGS

Coupes • Convertibles • Fastbacks

- New & Used Cars & Parts
- Mechanical Repairs
- Floors Completely Rebuilt

(609) 692-3178

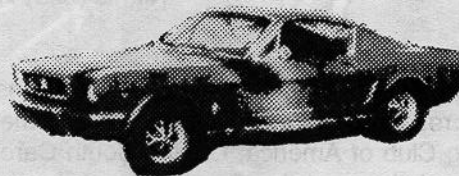

Buy one off our lot, and we'll tailor it to your taste!

3576 Northwest Boulevard, Vineland, N. J. 08360

MUSTANG CLUB OF AMERICA

FALL NATIONALS

Hosted by the Central South Carolina Regional Group
September 14-16, 1984

SHOW SITE
South Carolina State Fairgrounds
Columbia, SC

BANQUET
Location and price to be announced
7:30 PM on Saturday, September 15

HEADQUARTERS
Carolina Inn
937 Assembly St.
Columbia, SC 29202
Rate: \$39 (1 to 4 people)
Specify Mustang Show
(803) 799-8200

Entry Form

YOU MUST BE A MEMBER OF THE MUSTANG CLUB OF AMERICA TO ENTER

Name _____ Membership No. _____ Exp. Date _____

Address _____ City _____ State _____ Zip _____

Year _____ Body Style _____ Serial No. _____ S M U S S R \$ _____
T O N T R. E

Year _____ Body Style _____ Serial No. _____ C I E E D T \$ _____
K F S E T V T I R E D

Swap Meet Spaces 10/20 — \$30 each space.
(Only Mustang, Shelby, Boss and Ford Related Parts)

Number needed _____ \$ _____

Raffle Tickets \$1 each for 1966 Pony Convertible

Number needed _____ \$ _____

Free T-Shirt for pre-entry. Size _____

Pre-entry deadline August 3, 1984. Car registration \$10 for pre-registration.

Late entry deadline is August 31, 1984. Car registration \$15 for late registration.

NO CARS WILL BE REGISTERED AFTER AUGUST 31, 1984.

Mail payments to: Central South Carolina Regional Group
P.O. Box 2614
Columbia, SC 29202

For additional information contact: Craig Zion
Days (803) 533-1410
Nights (803) 791-3149

Robert Oswald
(803) 755-1299

I agree to abide by all rules and regulations of the Mustang Club of America and understand that I am responsible for my automobile and merchandise. I agree to release all liability from the Mustang Club of America, Central South Carolina Regional Group, South Carolina State Fairground Association and the Carolina Inn for any damage, injury, lost or stolen merchandise from this event.

Signature _____

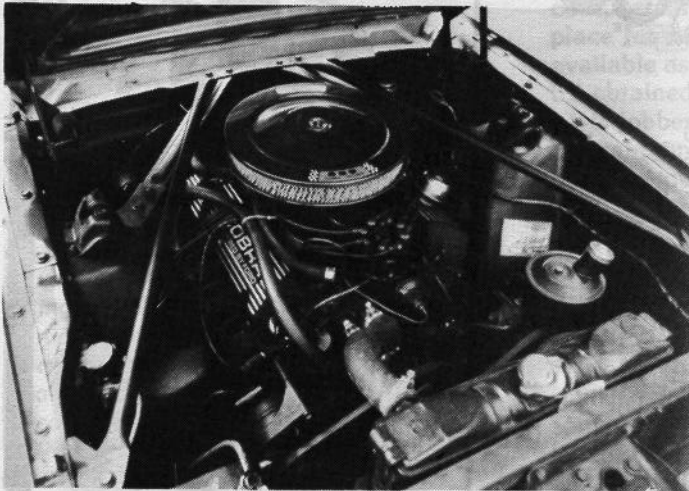

Rangoon Red Convertible

John Waldron was a resident of Honolulu, Hawaii in 1965 and it was there that he purchased his 1965 convertible. This Rangoon red convertible was manufactured on January 13, 1965 at the San Jose plant and is equipped with standard interior, full length console, woodgrain steering wheel, day/night mirror, 289 engine with dress-up kit, automatic transmission, style steel wheels and white convertible top.

In 1967 John moved to Pennsylvania taking his convertible with him. During the years the car has been used not only by John but also by members of his family resulting in 107,000 miles. New floor pans and torque boxes have been installed and the engine has been completely detailed with the assistance of Mid-County Mustang in Exton, Pennsylvania.

The convertible is carefully maintained and is now used on a more limited basis. With each appearance this pony draws plenty of attention.

MT



ACCESSORIES

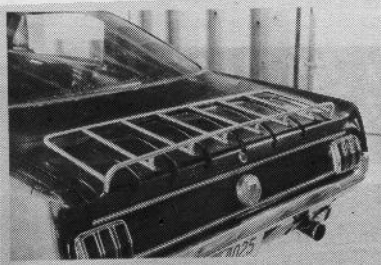

FREE 1984 CATALOG

EXTERIOR PARTS

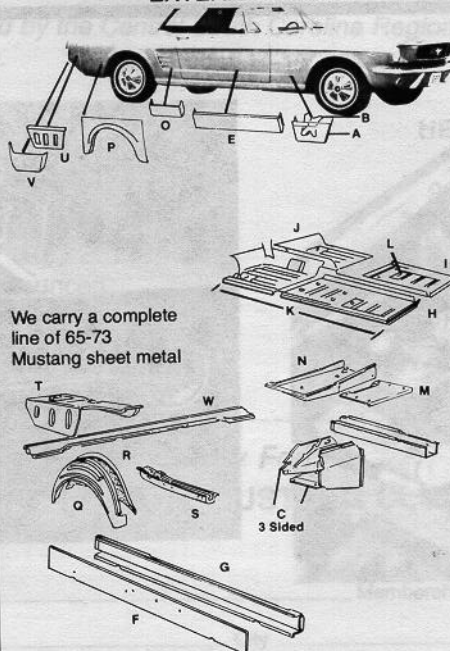

We carry a complete line of 65-73 Mustang sheet metal

¹ Due to the difficulty involved with their installation, long front or full side floors are not recommended for use in convertibles.
See Remainder of Exterior section for additional body panel listings.

MECHANICAL PARTS

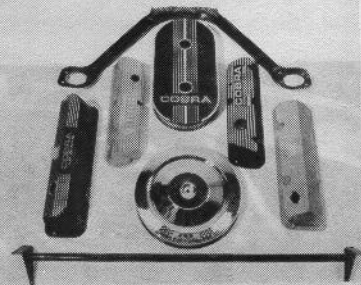

INTERIOR PARTS

The Most Experienced Mustang Restorer in The United States

Glazier's Mustang Barn

531 Wambold Rd., Souderton, PA 18964 — Open 9-5 Mon.-Fri.; 9-4 Sat. (Parts Only)

(800) 523-6708

(215) 723-9674

(215) 723-3722

(800) 523-FORD

PARTS: Cont. USA Exc. PA

PARTS: All other locations

Service Department

(PA area only)

New Products and Special Prices

Accessories
Poster

20 years of Mustangs new \$6.00 ppd.

Car Covers

0158 1965-68 Cpe. or Cvt.¹ ... Special \$120.00
0159 1965-68 FB, 69-70 all¹ ... Special 120.00
0160 1965-68 Cpe. or Cvt.² ... Special 100.00
0161 1965-68 FB, 69-70 all² ... Special 100.00
0162 1971-73¹ ... Special 120.00
0163 1971-73² ... Special 100.00
0165 Storage bag for covers listed above ... 5.00

¹Superior water repellent technalon fabric
Recommended for cars kept outside

²Water repellent tan flannel
Recommended for cars kept inside

Also available Green Drill loose fit car covers ... Special 80.00

Exterior Parts

Grill Horse and Corral
0521 1966 std. ... Special 40.00

Hood Tachometer

0968 69-71 ... New 90.00

Torque Box (3 sided)

1224 68-70 RH Cpe. or FB ... New 60.00
1225 67-70 LH Cpe. or FB ... New 60.00

Rear "Under" Seat Panel

1266 65-68 RH ... New 45.00
1267 65-68 LH ... New 45.00

Quarter Repair Panel (wheel flare to door)

1594 65-66 RH ... New 55.00
1595 65-66 LH ... New 55.00
1596 69-70 RH ... 80.00
1597 69-70 LH ... 80.00
1598 71-73 RH ... 80.00
1599 71-73 LH ... 80.00

Lower Rear Quarter

1663 71-73 RH (12") ... New 40.00
1664 71-73 LH (12") ... New 40.00

Gas Cap

1903 67 (exc. GT) ... New 40.00

Window Weatherstrip Kit

2610 65-66 FB, RH and LH, door, outside and inside (4 pcs.) ... New 30.00
2611 65-66 Cpe. or Cvt., RH and LH, door and quarter, outside and inside (8 pcs.) ... New 40.00
2612 67-68 Cpe., RH and LH, door and quarter, outside and inside (8 pcs.) ... New 40.00
2613 67-68 Cvt., RH and LH, door and quarter, outside and inside (8 pcs.) ... New 40.00
2614 67-68 FB, RH and LH, door, outside and inside (4 pcs.) ... New 30.00

Rear Window Weatherstrip

2707 67-68 FB ... 100.00
2708 69-70 FB ... Special 55.00

Interior Parts

Dash Pad
65 or 66 Black, Blue ... Special 145.00
65 or 66 Other colors (dyed) ... Special 160.00

Headliner

3076 65 Cpe., Med. Blue ... New 35.00
3077 65 FB, Med. Blue ... New 35.00
3080 67-68 Cpe., Med. Aqua ... New 35.00
3081 67-68 FB, Med. Aqua ... New 35.00

Sunvisor Bracket (pr.)

3119 67 Cvt., RH and LH (incl. pivots) ... 80.00

Heater/Defroster Air Chamber

3231 65-69 (exc. 69 w/AC), plastic ... New 40.00

Heater Seal Kit

3238 65-66 ... New 12.50
3239 67-68 ... New 12.50

AM/FM Stereo Radio and Cassette Player

3440 65-66 aftermarket ... Special 140.00

Gear Shift Knob

3505 65-67, Manual, 3-speed ... New 30.00
3507 68-69, Manual, 4-speed ... New 30.00

Shift Boot Retainer M/T

3567 Late 65-68 ... New 15.00

Door Courtesy Light Wire Harness

3971 65-66 w/Pony int. & door speakers, RH or LH ... New 33.00

Arm Rest Base

4075 65-66 RH or LH w/std. interior¹ ... Special 12.00

Pony Door Panel Assembly (pr.)

65 or 66 all colors ... Special 140.00
¹Not incl. moldings or cups

Top Boot

5381 67 saddle ... 42.00

Top Boot Storage Bag

5384 Black ... 5.00
5385 White ... 5.00

Cvt. Top Tacking Strips (3 pc. set) rpl.

5435 65-68 ... New 115.00

Trunk Mat

5502 65-66 Cpe. or Cvt., plaid (matches available tire cover) ... 20.00
5503 65-66 FB, plaid (matches available tire cover) ... 20.00
5514 67-68 Cpe. or Cvt., speckle, rubber ... 30.00

Mechanical/Operational Parts

Styled Steel Wheels

6023 Magnum 500 14" x 7" ... Special 90.00
6024 Magnum 500 15" x 7" ... Special 90.00

Tri-Y Headers

6400 65-66 GT-350 (will fit 289 or 302) (incl. attaching hdwe.) ... Special 150.00

Tailpipe Extension Dual Exhaust

6460 65-66 GT RH w/289 ... Special 50.00
6461 65-66 GT LH w/289 ... Special 50.00

Battery Post Rubber Shield

6724 65-66 (mounts on fender apron) ... New 2.00

Firewall To Engine Ground Wire

6880 65-67 ... New 5.00

1965-1973 MUSTANG PARTS AND SERVICE

Shipping costs are extra. Prices and availability are subject to change. MC-VISA-COD.

A F S R K E D

Do you have a question of a technical nature, and you're just not sure about the answer? Ask us. Fred Glazier of Glazier's Mustang Barn is now assisting us with the technical information portion of our publication. Please send all questions directly to National Headquarters. Your answer will appear in an upcoming issue of Mustang Times.

Q. Dear Fred,

I have a 1972 Mach I with the 351 2-V. This summer I want to do something to the engine to make it more of a performance car. I was wondering if you could change the 351 2-V into the 351 HO built in '72? If not, any suggestions as to building up the engine would help.

Would a tri-power set-up fit a 351?

Tommy Nabors
Columbus, MS

A. Dear Tommy,

You could do modifications to the 351 2-V to increase the output; however, you could not convert it into a 351 HO because of the many differences in internal parts.

The Tri-power from a 406 would not fit a 351.

Fred

Q. Dear Fred,

I have a 1968 GT hardtop and I have to replace the front coil springs. When I used to work for Ford I knew they had a special tool for this.

I no longer have access to this tool. Is there any tool I can purchase for this job? External spring compressors do not seem to work because of limited space, or will they?

Mike Grentus
Towaco, NJ

A. Dear Mike,

We do use an internal spray compressor to remove and replace Mustang coil springs. It is available as OTC Part # and can be obtained through your local parts jobber or you could probably rent one from a local tool rental company.

Fred

Q. Dear Fred,

I own a '66 coupe, 289, with P/S and A/T.

When hitting a dip, there is a clunking noise in the front end as if something is loose. The noise is louder when turning and hitting a dip. At this time it is felt in the steering wheel as a jerk.

While driving, the car wanders.

I have replaced the shocks, tires, upper ball joints, shock saddles, lower arm assembly, strut rod bushings, P/S hydraulic control ball stud, steering column bearing, and stabilizer bar bushings, but the noise is still the same. Also the wheels have been balanced and front end aligned.

When inspecting the car on a rack, everything is tight.

What do you think is causing this problem?

Andy Parrino

A. Dear Andy,

I would check the condition of the motor mounts and the motor mount attaching brackets that attach to the frame. If the bolts are loose this could cause the noise you describe. You might also check the upper and lower control arm bushings for wear.

The worm and sector in the steering box could be worn or out of adjustment to cause the wandering in the steering. You might also check the condition of the rear axle components. Any shifting in the rear can also cause the sensation of steering wandering.

Fred

Q. Dear Fred,

I am a member of the Mustang Club of America, and have a problem finding the difference between

a 351 4-barrel Cleveland and a 351 Cobra Jet engine. The car is a '72 Mustang convertible and the person I bought the car from told me it is a 351 Cobra Jet. Since all 351 4-barrel engines identification numbers for that year is a "Q" except for the 351 high output which is an "R" it has made it difficult for me to justify what engine is really in my car. Your help would be greatly appreciated.

Leonard Wessil
Vernon, NJ

A. Dear Leonard,

The 351 Cleveland has canted valves with multi-groove keepers, hydraulic cam, pedestal-mounted rocker arms with "Sled" fulcrum seats that are retained with cap bolts. Heads for 2-V have "open" chambers with rounded ports while 4-V heads have larger rounded intake & exhaust ports. The 351 Cleveland Cobra Jet has 4-bolt main caps. Hope this clears up some of the confusion.

Fred

Q. Dear Fred,

I have just purchased my second 1967 coupe. When checking it out I realized that it has all the equipment for air conditioning on the engine, but nothing inside. It looks as if it had an underdash air conditioner at one time (i.e., smashed carpeting under dash and a hole in the flooring possibly for a drain hose). Is this original? Could this be a dealer-installed unit? Where can I get this unit?

Any information will be a great help.

Ron Brunson
York, PA

A. Dear Ron,

Ford did offer an underdash dealer-installed air conditioning for your car. This unit is no longer available through Ford but could probably be located through a Mustang vendor or at an automobile flea market.

Fred

MT

The Mistress

By
Harold R. Wiltraut

I remember it well! It was a Friday afternoon following Thanksgiving, and any sane person would have been watching a football game and nursing a turkey hangover. Instead, I was lying on a cold garage floor trying to convince myself that I was happily pursuing a rewarding hobby . . . restoring an old car. My neck ached. My arms felt as if they had been holding up the entire world instead of an oxy-acetylene torch. I was chilled to the bone, and to complete my misery, a hot spark had just found its way into my left ear.

As I labored away, I tried to console myself by thinking of all the things I had ever done in my life which could be considered dumber than buying a down-at-the-heels collector car. I couldn't come up with a single thing (except maybe joining the Army) and that only added to my misery.

I had no one to blame for my predicament but myself. I should have been aware of the many difficulties involved in restoring old cars from the many car shows I had attended over the years, and from all the "car-nut" magazines I had devoured. But, apparently not much stuck, so here I lay, on my cold behind.

I did have one consolation though, in the form of a good friend, Hoppy Halpin. He was quietly shivering alongside of me, apparently secure in the knowledge that one had to be kind to drunks, mad Englishmen and dreamers such as I who bought clapped-out collector cars.

And I was a dreamer . . . with a dream that had started 18 years ago when I had my first glimpse of a beautiful mistress in the form of a pure-white '65 Mustang convertible. But the mistress now squatting above us had turned out to be a decrepit old lady. Her white paint was grey and cracked, and it hid more colors than a rainbow. She was swaybacked, knockneed and fatigued. Her "facelift" had been installed with few bolts and much faith. (She jiggled when she moved.) She had lost her I.D. papers and to complete her indignities, she had a buckled rear. As Hoppy and I undressed her further and further we discovered more and more problems, and thus began a year-long adventure in the dubious art of amateur Mustang restoring, (Hoppy actually did most of the work, in his own garage, no less, while I spent a good deal of time just standing around . . . in awe.)

I don't wish to bore the reader with the fine details of this adventure, but I would like to highlight some of the great truths I learned from it. Certain of these truths are so profound they can almost be considered laws. Also, they've had the benefit of multiple testing, not only by me, but by anyone who's ever fooled around with cars, and the results do repeat.

Here then are my learned observations:

1. All rubber covered electrical cords, air hoses and gas lines have a built-in design characteristic which allows them to become hopelessly entangled when in use. One overcomes this annoyance only by substituting rigid copper tubing for the rubber.
2. The inexperienced (read amateur) eye cannot readily discern a one-sixteenth inch size difference between a nut and a wrench. This problem is easily overcome, though. Simply move the tool box as close to the nut as possible, or do as a photographer does with his exposures; bracket the wrench sizes. The unneeded wrenches can be carried in your right rear pants pocket.

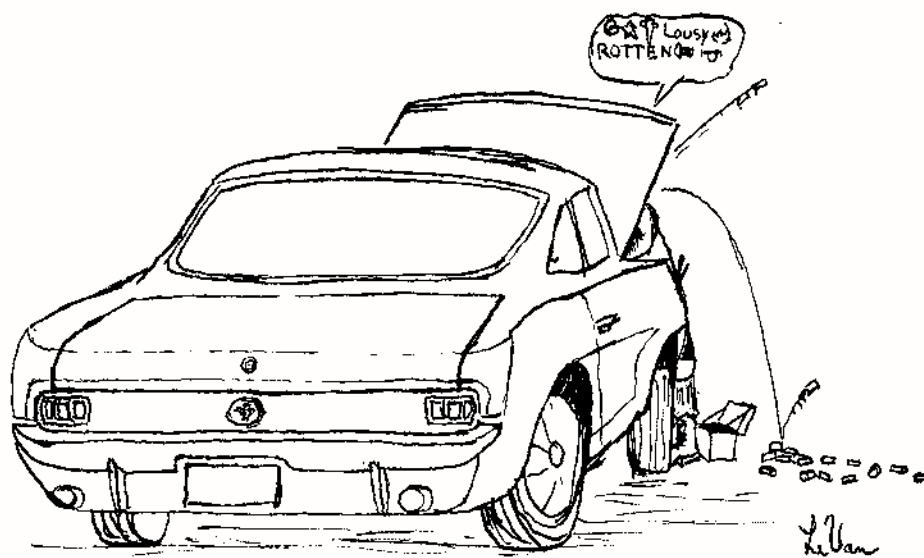

3. Screwdrivers, when dropped on the floor, will always roll at least 1 inch beyond one's normal reach. Avoid this aggravation by always carrying two extras in your left rear pants pocket.
4. If "anything" is planning to drop from the bottom of an old car, it will always wait until one's face is directly beneath it. This simple fact can be verified by studying Newton's 2nd Law of Universal Gravitation, a U.S. Air Force Bombardier's Training Manual, and Webster's definition of the word "obnoxious." Be careful of this one because there's more to it than "meets the eye." Any defense? Not much really, except to at least keep your mouth closed when working under an old car and always carry a wiping cloth in your right front pants pocket.

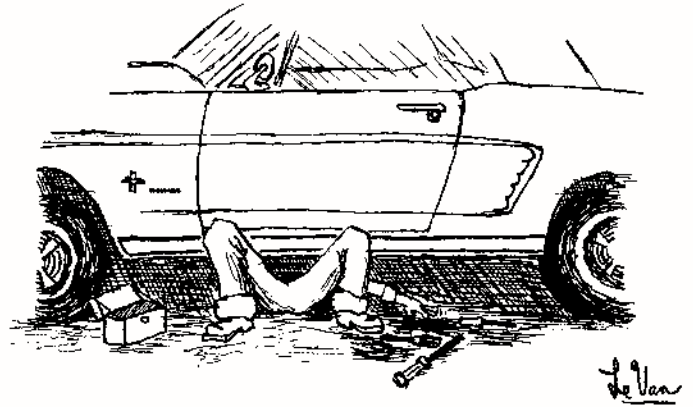

5. The quality of a new paint job is directly proportional to the number of flying insects within a five mile radius.

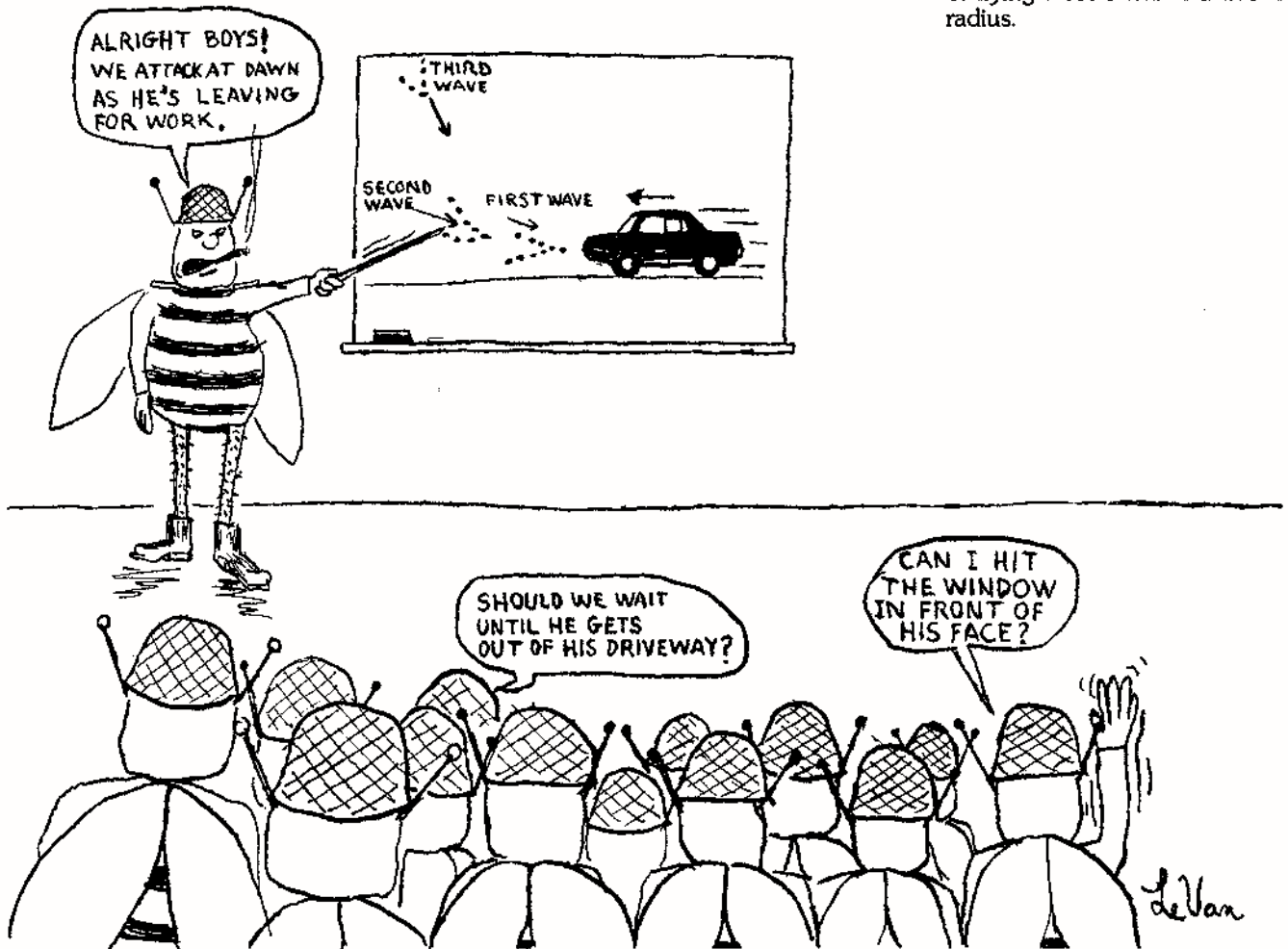

6. The human back was not designed to work over, under and around automobiles. This fact might account for some of the grumpy auto mechanics we've all run into at one time or another.
7. Trouble-lights (especially the ones with the little hook) always cast at least 90% of their illumination on areas where it is not needed. Therefore, it is always a question of whether or not the remaining 10% is adequate for the task at hand. It usually isn't, so always carry a flashlight in your left front pants pocket.
8. A certain percentage of the parts removed from a car are not needed when it's put back together again. I might get an objection from Mr. Goodwrench on this (unsafe repair job, you know) but, I have a box of assorted parts in my garage which I know for a fact came from my Mustang, and it runs perfectly fine without them. Incidentally, these extraneous parts can be collected in your shirt pockets or pant cuffs while working.
9. When visiting an auto-parts jobber or flea market, always assume you're going to come away with only one-half the parts you wanted, and that they will cost twice as much as anticipated.
10. Don't automatically believe the parts clerk when he reads from his big parts book and tells you that Part #49303954-0kk103-40 is going to fit your Mustang. This is impressive as hell, but it will not add the required third hole in the flange of the struggle-buggy suppressor when you're trying to install it.
11. This item pretains to auto junk yards, and can at times literally spell the difference between life and death. To stress its importance and to make it easy to remember, I've broken it into two separate parts:

- a. Always carry copious quantities of salt water taffy in your tool box for the junkyard dog. This keeps both him and his jaws occupied.
 - b. Always loudly announce yourself when approaching a derelict car in order to allow the critters which might be inhabiting it, time to make their escape. This can be accomplished by singing, or by banging on a body part and exclaiming "Wow, what a nice straight '66 Fastback."
- There is an important corollary to Part b., however . . . there does exist in this world such a thing as a deaf snake.
12. No one should even consider restoring an old car without the support of good friends and an understanding mate.

Well, there are my Twelve Great Truths of Amateur Auto Restoring. They aren't chiseled in stone, but they are borne out of a little blood, some sweat and much aggravation.

My adventure is over now, but I occasionally think back to that grey November afternoon . . . and to the times of frustration, scraped knuckles and impending bankruptcy. But all is well now, especially when I'm riding around on a soft summer's night, with the wind in my hair, Willie Nelson on the old DeLuxe, and people turning their heads in envy as I pass. Yes, all is well. Hoppy still considers me a friend (I think), my wife has cancelled the divorce proceedings and I'm the proud guardian of a lovely, pure-white mistress (and topless, too). How lucky can a guy get!!!

MT

Looking for Upholstery?



AFTCO is your one stop shop for upholstery and interior related items for 1964½-1973 Mustangs.

Send a SASE (2 stamps) for your **FREE** catalog today.

AFTCO

P.O. Box 278-MT
Isanti, MN 55040

(612) 444-4025

FREE OFFER from *Super Ford Magazine*, the largest all-Ford Performance and Restoration publication in the World! We're celebrating our 9-year anniversary by offering, at no obligation, two issues of *Super Ford Magazine* absolutely free to non-subscribers. *Super Ford Magazine* provides Ford enthusiasts exclusive columns like: NASCAR FORDS, tech line, News from Ford, In The Fast Lane, Ford Motorsport News, Ford and Mercury club reports, Formula Ford, engine articles, drag racing coverage, coming events, the Super Ford Collector series, full color features of your favorite Super Fords . . . and our giant advertising section gives you all Ford and Mercury classified and display advertising from throughout the United States and 22 foreign countries! To test drive *Super Ford Magazine* and receive two issues absolutely free at no obligation, send your name and address with \$1.00 to cover postage to:

SUPER FORD MAGAZINE
Department 8, P.O. Box 359
Seneca Falls, N.Y. 13148

FORD POWER

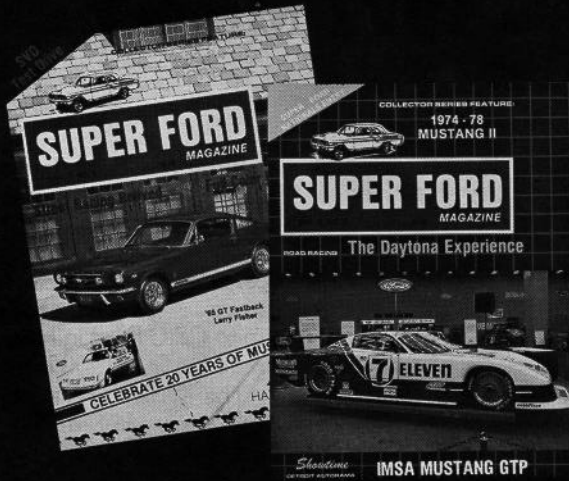

SUPER FORD MAGAZINE - The largest all Ford Performance and Restoration publication in the World provides Ford enthusiasts exclusive columns such as: NASCAR FORDS, Tech Line, News from Ford, In the Fast Lane, Ford Motorsport news, engine articles, drag racing coverage, Formula Ford, Ford and Mercury club reports, coming events, the Super Ford Collector Series, new product information, full color features of your favorite Super Fords . . .

AND OUR GIANT ADVERTISING section gives you all Ford and Mercury classified and display advertising from throughout the United States and 22 foreign countries!

WE ARE AN AGGRESSIVE PUBLICATION that combines history from Fords in the past, news of Fords in the present, and all about what Ford has planned for your future. **SUPER FORD MAGAZINE** encompasses the full spectrum from racing to restoration while providing you a monthly smorgasFORD of cars, parts, literature, and services, in the comfort of your own home. **DON'T DELAY!** If you're into Fords and Mercurys, this is the complete Ford magazine you've been waiting for!

SUBSCRIBE TODAY! 12 BIG ISSUES PER YEAR

Subscription information United States only \$20.00 per year. First Class \$39.00 per year. Outside USA (all funds at US exchange) Canada & Mexico \$34.00 (Air Mail \$39.00) per year, all other foreign subscriptions Air Mail \$49.00 per year. Send check or money order to **Super Ford**, Dept. 8, PO Box 359, Seneca Falls, N.Y. 13148. Now you can use your MasterCard or VISA to subscribe. Just phone or write **Super Ford** with the information on your charge card (Phone 315-568-2011 between 9 a.m. and 5 p.m.)

Show us this ad at the Super Ford Street Machine Nationals and save \$3.00 off the regular subscription price and receive four free back issues.

SUPER FORD
MAGAZINE

NUMBER 1 IN FORD PERFORMANCE

Don't Miss The 1984 SUPER FORD STREET MACHINE NATIONALS

August 10-12 in Utica, Michigan

- 1200+ Super Fords
- Swap Meet
- Car Show
- Drag Racing
- Games and much more

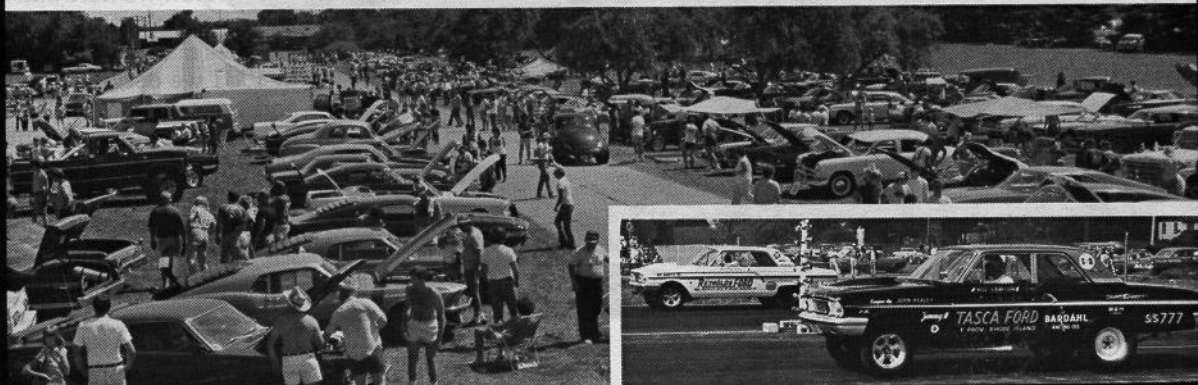

For further information contact: **SUPER FORD**, 172 Fall St., Seneca Falls, NY 13148 Phone: 315-568-2011

Jim & Peg Wak's 1971 Mach I



Early one Saturday morning in August of 1971 I went over to the garage and fired up my 1968 GT-500KR for the last time. The car was taking its one last ride, with me as the owner, (dumb move . . . yes). The KR was on its way up to C&C Ford in Horsham, PA to be traded in for \$1900 on a 1971 Mach I.

The Mach I was a lot more practical for every day driving, sporting a 351-2V engine with A/C compared to the Shelby with its 560-H.P. and 4.3 MPG Gas was cheap in 1971 but NOT THAT CHEAP. The car was ordered with quite a few options: 351-2V, automatic, Mach I sports interior group, console, gauge package, disc brakes, tinted glass, but — there were quite a few more that couldn't be afforded at the time like side stripes, ram air, twist locks, spoilers, stereo, mags, etc.

The day I picked up the car enough money was put together to buy the magnum wheels and F-60 tires from C&C and away I went. By August of 1972, after many trips to the parts and service departments, all the options I had wanted were now installed on the car.

I drove the car till 1973 when I married my wife Peg. Now, I was driving a company car and Peg, the Mustang. With fuel prices sky rocketing we decided in 1980 to buy an economy car and retire the Mach I from daily driving.

Armed with all our cleaning supplies, we proceeded to clean-up and detail the car as best we could, at the time. For our efforts we succeeded, much to our surprise, in taking home a second place trophy. Now we were bitten by the bug, with more cleaning and detailing we won five more trophies in seven shows. In 1981 we decided to pull the engine and transmission, we detailed the engine compartment completely. Bill Marsh Ford parts department became my second home. I received assistance from the manager Ed Sherwood, and also Tim Keller in helping to locate the parts needed to restore the car to new.



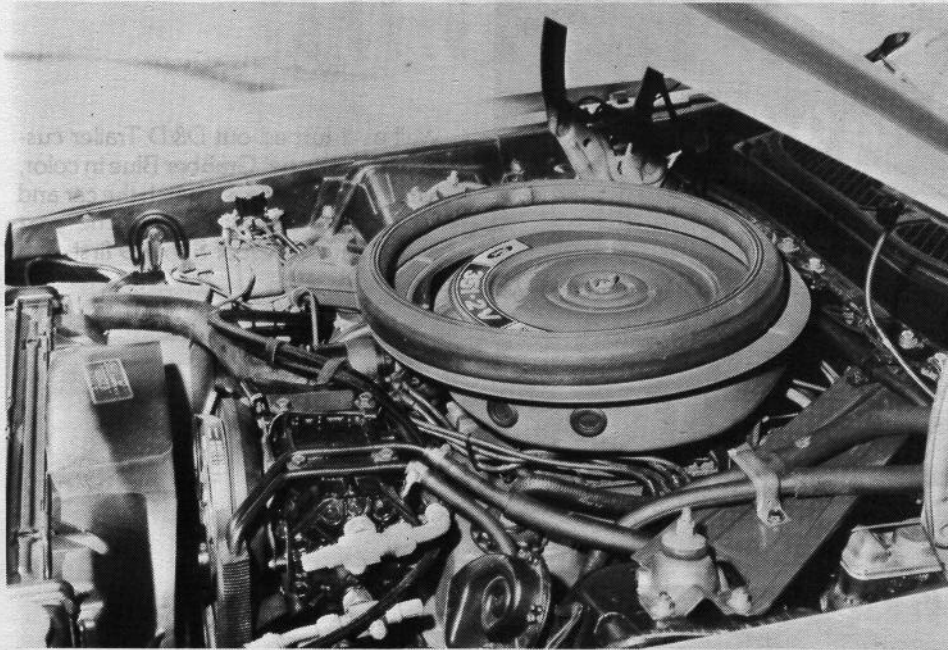

The appreciation Peg and I feel can never be expressed enough. Our big decision came in March of 1982 when we decided to go all out and have the car repainted. Being out in the weather from 1973 to 1980 took its toll on the finish. This task was done by Greg Link, now owner of G&G Body Works in Ambler, PA. After completion of the paint job in mid-summer, we spent many hours reassembling the car and getting it ready for its first show of the year.

We were entered in a total of five shows for the season and took five first place positions, one being the Grand Nationals at Valley Forge, PA. The 1983 season was again decision making time for Peg and I. Should we have a trailer built and go to the Grand Nationals, or stay local with the shows.

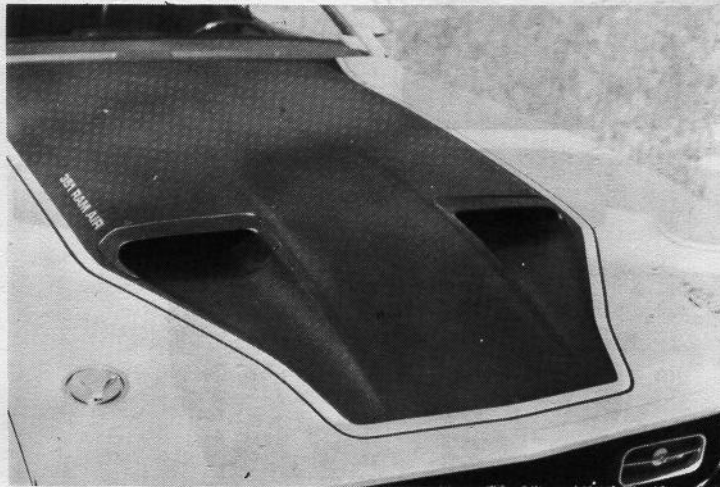

Data Plate Information on Jim Wak's 1971 Mach I Fastback: Body 63R; Color J; Trim 5A; DSO 16; Axle 6; Trans. X. V.I.N. #1T05H151759. 1971 Mach I Fastback, 351-2V Automatic, Grabber Blue Exterior with Black Interior and Accent Striping.





Well as it turned out D&D Trailer custom built us one; Grabber Blue in color, at Peg's insistence, to match the car and we went to Knoxville, TN. The year ended with 1 Best of Show, 9 first, and 1 second.



With the '84 season approaching fast we are feverishly working to get the car ready again, looking forward to seeing a lot of old friends, and meeting a lot of new ones. We would like to thank Scott Hamburg of Colony auto in Newtown, PA for his help and advice. Again, many thanks to our friends Ed, Tim, and Jim of Bill Marsh Ford parts department. A special thanks to Greg for the excellent paint job.

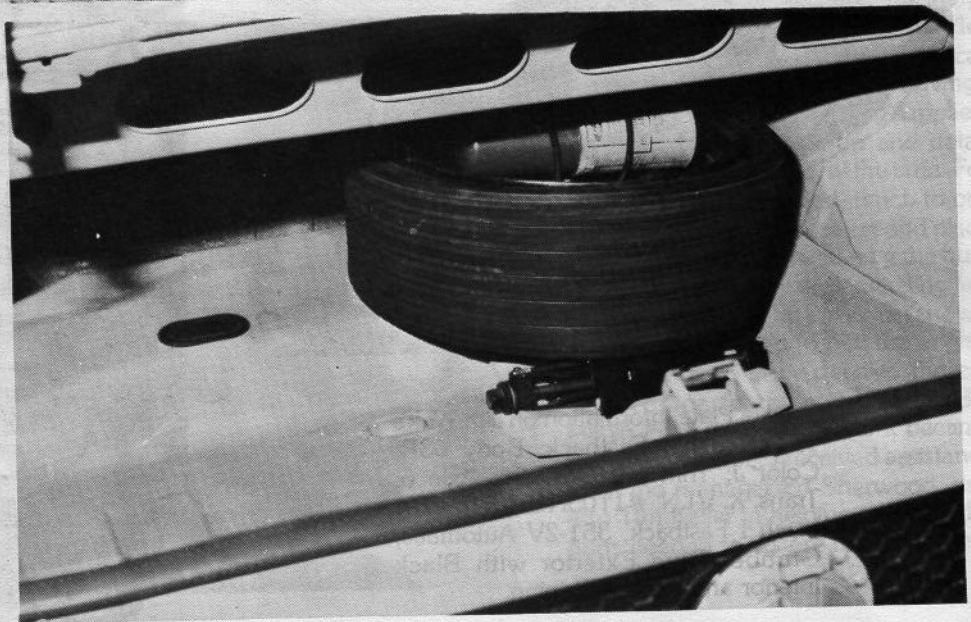



Memories of my Stang

One sunny day I approached my pride and joy, eased the drivers side door open and slid behind the wheel. The feeling was like none other, we had arrived. The two of us had become one, one love, one joy as we moved on down the road. As one we glide over the asphalt like music. We could feel the appreciation of many as we passed by their way and the thrill of the Mustang-feeling as we slowly pulled up to the red light. As one we waited with anticipation with the knowledge that a

new experience could happen any moment. I thought back on my life's work in keeping this beauty in top condition and quite confident of its excellent performance. Yes, memories of my stang, what a beautiful way to have spent a sunny day.

Peg & Jim Wak
Newtown, PA

With special thanks to Mike Holzer of Hatfield, PA for the very good sketch of our car.

MT

AUTHENTIC MUSTANG UPHOLSTERY

AUTHENTIC MUSTANG UPHOLSTERY for the discriminating owner interested in having the CORRECT INTERIOR in his Mustang. All of the vinyls are reproductions of the originals and are correct in color and grain.

Quality upholstery and the best foam rubber available in the seat inserts gives a lasting wrinkle free pleat, DACRON THREAD wears like iron, HEAVY BACKING for the underside of the seat inserts, CORRECT NUMBER OF PLEATS in the seat inserts. ALL FRENCH SEAMS sewn with a Double Needle machine to give straight, parallel seams and the best Seamstresses in the business. Please write or phone for FREE SAMPLES of vinyls. Upholstery, as well as every item that I sell, has an instant money back guarantee if you are not satisfied.

NEW
69-73
UPHOLSTERY
PHONE FOR PRICES

STANDARD INTERIOR

1965 Black, White, Metallic Blue, Red, Palomino, & Ivy Gold.	
1966 Black, Parchment, Metallic Blue, Metallic Red, & Aqua.	
1967 Black, Parchment, Red, Two Tone Blue, Two Tone Aqua, & Two Tone Ivy Gold, Palomino	
1968 Black, Blue, Turquoise, Ivy Gold, Red, Parchment	
Seat Covers for one Bucket Seat; includes Cushion Cover, Backrest Cover, and "Stitch Rule Embossed" material to cover the back of Back Rest	74.95
Seat Covers for two Bucket Seats; as above	138.95
Seat Covers for Bench Seat; as above	159.95
Complete Set of Seat Covers; front and rear as above, with Buckets	189.45
Complete Set of Seat Covers, front and rear as above, with Bench	221.95
Rear Seat only	112.95

PONY INTERIOR

1965 Black, Red, Blue and White, Palomino, Ivy Gold/White,	
1966 Black, Blue and White, Parchment, Ivy Gold, White, Turquoise/White, Red	
Seat Covers for two Buckets	192.50
Seat Cover for one Bucket	98.00
Seat Covers for two Buckets and Back Seat	274.80
Rear Seat only	149.95

These interiors are the most authentic reproductions available today. Special attention has been given to match the PONY INSERT, colors, and grain in every detail.

CARPET SET

Includes front and rear carpets, nylon loop pile type, with color keyed heel pad and Jute underpadding. Available in black, red, medium blue, fawn, olive green, brown, saddle, dark green, dark blue, turquoise, and maroon.

STANDARD CARPET: with sewn corners.

65-73 Hardtop (65) or Convertible (76)	65.00
65-73 Fastback 2 plus 2, (63)	65.00
65-73 Fastback 2 plus 2, (63), including rear seat fold down area	87.00

MOLDED CARPET; like the original with Heel and Side pads.

Available in most colors.

65-68 Hardtop (65), Convertible (76), or Fastback 2 Plus 2 (63)	105.00
65-68 Fastback 2 Plus 2 (63), including rear seat fold down area	122.00

HEADLINERS

Original type vinyls of correct colors and grain and are guaranteed to fit.

Available in all the original colors.

65/70 Moonskin grain vinyl, 71/73, Tier grain vinyl.

Please specify year, body style, and color desired when ordering

35.95

HEADLINER INSTALLATION KIT

Includes instructions and glue for the proper installation of Headliner

2.50

CONVERTIBLE TOP

Our top quality vinyl convertible top material is guaranteed against defects in workmanship and materials for three years (exc. rear window)!

65-73 Convertible Top with Plastic Curtain

White, Black	114.95
Beige, Ford Blue, Red, Tan, Green	124.95

65-70 Convertible Top with Folding "Glass" rear window

White, Black	209.95
Beige, Ford Blue, Red, Tan, Green	219.95

Note: For 65-66, Replace well cover with 67-68 type.

71-73 Convertible Top with one-piece "Glass" rear window

White, Black	205.95
Beige, Ford Blue, Red, Tan, Green	215.95

Note: Colors other than Black or White are Special Order only. Please allow 4-6 weeks for delivery.

CONVERTIBLE TOP PAD SET

Set of Two	18.95
------------	-------

CONVERTIBLE QUARTER TRIM COVERS

Available in the same years and colors as Seat Covers	Pair 39.95
---	------------

WELL COVER

Fits between the rear seat and the trunk.

65-66 Black or White	19.95
----------------------	-------

CONVERTIBLE TOP BOOT

A quality vinyl boot complete with correct attaching hardware.

Colors available:

1965 White, Black, Ivy Gold, Med. Blue, Red, Palomino, Lt. Turquoise	
1966 White, Black, Ivy Gold, Lt. Blue, Dk. Red, Lt. Turquoise, Parchment	
1967 White, Black, Ivy Gold, Lt. Blue, Dk. Red	
1968/70 White, Black	
1868 Shelby, Black, Parchment	
BT-241 65/66	44.95
BT-241B 67	44.95
BT-241C 68, Mustang	46.95
BT-241D 68, Shelby	46.95
BT-241E 69/70, Mustang & Shelby	46.95
Storage Bag for above boot	4.95

LANDAU VINYL TOP

Made as per original in the correct grain and colors.

Quality vinyl, Dielectrically Seamed and guaranteed to fit!

65-73 Please indicate year and color desired	45.00
--	-------

TONNEAU COVERS

Available in Black only. Complete with all attaching hardware.

Guaranteed to fit perfectly! 65/66

89.95

VINYL WINDLACE

Pinch on type; indicate color desired

per foot .75

CAR COVER

Super Soft and Perfect Fitting! The finest material and

construction available. 65-73

79.95

SUN VISOR—LESS ARM & BRACKET

65-68 Available in all original colors, specify

body style and color

ea. 21.95

PADDED DASH

65 Black, Blue & Red	159.00
66 Black, Blue & Burgundy	159.00
69-70 Black, Blue; without Integral Air Conditioning	229.05
69-70 Black, with Integral Air Cond.	229.05
71-72 Green	146.90
73 Black, Blue, Ginger	246.10

DOOR TRIM PANELS STANDARD INTERIOR

65-68 All original colors available

Pair 111.95

DOOR TRIM PANELS PONY INTERIOR (less mldg.)

65-66 Pony interior, 67 deluxe interior

Pair 170.00

KICK PANELS

65-66 Black, White, Parchment, Red, Blue	per set 29.95
67-68 Black (63, 65)	per set 31.80

ARM REST

65-66 Pad, Specify color

19.60

67-68 Arm Rest, Specify color

25.85

TRUNK MAT

Genuine Ford N.O.S. (1965-1966 only)

41.55

Reproduced type, plaid or speckle (Specify year and model)

19.95

Note: Please add 10% for shipping within U.S.A., 5% for California. We pay the freight on orders over \$125.00.

To place parts orders, please call the Toll Free number. For your FREE price list, please write and be sure to specify which price list you need (55-57 T-Bird or 65-73 Mustang). Also available for just \$5.00 is our comprehensive 92 page Illustrated Mustang Parts Catalog. The \$5.00 includes First Class mailing or U.P.S. and all future updates of the Parts catalog and Price List. Just charge it to your BAC/VISA or MasterCard.

PHONE TOLL FREE 800-854-0393

In California call 714-871-6432



LARRY'S
THUNDERBIRD and MUSTANG PARTS

511 S. RAYMOND AVE. • FULLERTON, CA 92631

Prices subject to change without notice.

"HAPPY ANNIVERSARY" MUSTANG!

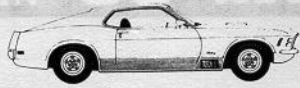

Ford Mustang "A Legend Turns Twenty" Poster

The MUSTANG, America's sports classic, is the subject of this investment — quality, full color "anniversary" poster featuring 29 MUSTANGS . . . from the original 1964½ SVO.

This 26" × 47" 4-color and foil poster is printed on heavyweight coated stock and is suitable for framing. Pictured are standard models and such well-known models as the GT-350, BOSS 302, and Indy Pace cars. The poster is shipped postpaid in a sturdy mailing tube.

Supplies are limited! This poster will definitely become a collector's item. Don't be sorry — order yours today. \$6.95 or two for \$10.95. Allow 3-4 weeks for delivery. Send check or money order to:

Mustang Classic Collections, Inc.
P.O. Box 539, Dept. P.
Pine Lake, Georgia 30072-0539

DEALER INQUIRES WELCOME

Celebrating **20**
YEARS OF MUSTANG

Attention M.C.A. Regional Groups!
SPECIAL REGIONAL GROUP PRICES
are available for "quantity" purchases of this "Collectors" poster. Send inquires on M.C.A. Regional Group prices to:

M.C.A. ACCESSORIES
1462 Wendover Court
Stone Mountain, GA 30083



**DALLAS
MUSTANG
PARTS**

YOUR NUMBER ONE SOURCE

REGULAR CAPACITY RADIATOR Suitable for use with factory A/C. Twelve month guarantee. All two row core. Fits manual or automatic transmission. Please call for prices on models other than shown.
1965/66, V-8, 6-Cyl.115.00

GADGET BAG Carries cleaning supplies, tools, parts, refreshments, etc. Made of trunk mat material and decorated with Mustang pony 16.95

REPRODUCTION TRUNK MAT
1965/70, Gray plaid F/B 19.95
1965/70, Gray plaid Cpe..... 19.95
1965/70, Gray plaid Cvt 19.95

REPRODUCTION TIRE COVER
1965/70, Gray plaid 12.95

JACK-PAC For jack and handle.
Matching material 4.95

BATTERY CABLE SET Exact reproduction of positive and negative battery cables and solenoid to starter cable.
1965/66, V-8 49.95
1965/66, 6-Cyl. 49.95
1967/69, V-8 and 6-Cyl. 49.95

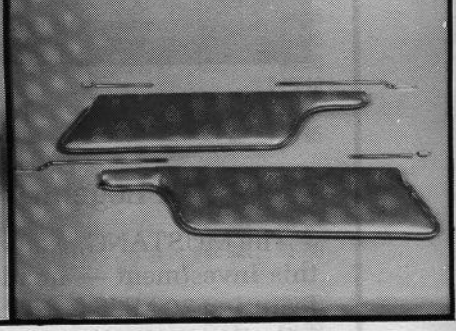
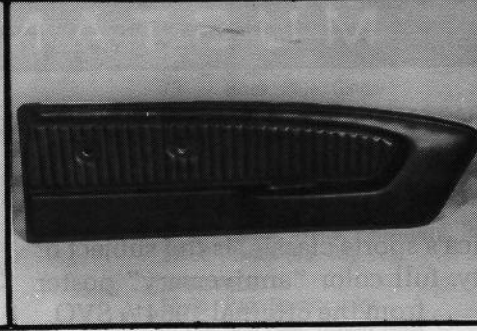
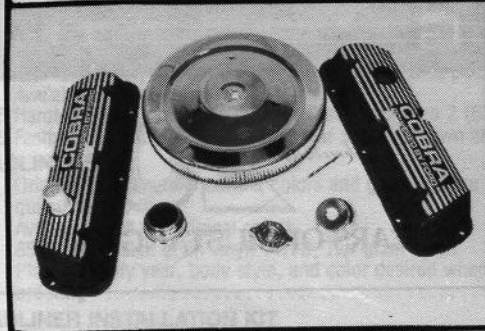
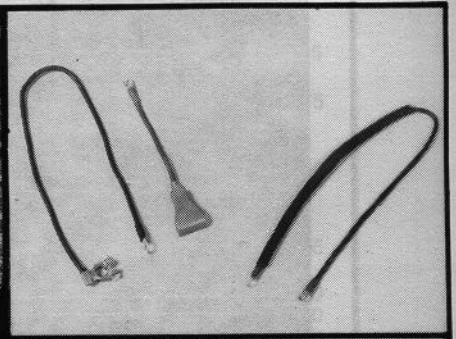
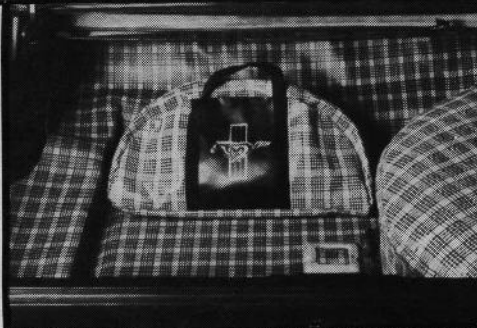
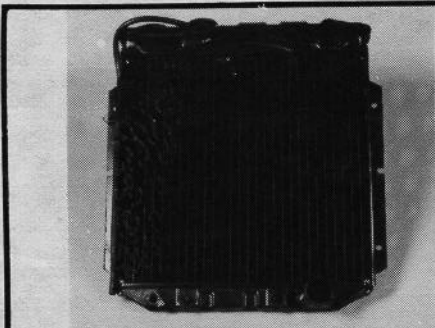

ENGINE DRESS-UP KIT 8-Cyl. Kit includes 2 Cobra valve covers, chrome air cleaner, chrome oil filler cap, chrome radiator cap, chrome oil dip stick & chrome master cylinder cover.
1965/68, 260-289-302129.95

ALL-NEW PONY DOOR PANELS The finest reproduction you'll ever see. Available in Black, White, 65 Red, 66 Red, Parchment.
1965 Panels PAIR 149.95
1966 Panels PAIR 149.95
1967 Deluxe Door Panels PAIR 210.00

SUNVISORS Exact reproduction of the original available in all original colors
1965/68 PAIR 39.95

CONVERTIBLE SUNVISOR RODS
(4 pcs.) Chrome SET 14.95

SUNVISOR RUBBER TIPS EACH .75

ORDER INFORMATION

- VISA or Master Card
- Texas residents add 5% sales tax
- Exact freight charges on orders under \$150
- Prepaid over \$150
- Same day shipment UPS
- COD shipments
- All merchandise in stock
- Please specify color, make, year & model

Store Hours: Monday - Friday 8 AM - 5 PM

Saturday 8 AM - 2 PM

**9515 SKILLMAN STREET
DALLAS, TX 75243**

Your calls will be a

FOR CONCOURSE PARTS

**DALLAS
MUSTANG
PARTS**

PONY DOOR HANDLE WOOD GRAIN

KIT Die Cut, just like original
1965/66 PAIR 4.95

CAR COVERS-READY FIT

Fits over the entire car, bumper to bumper. Water repellent. Mildew resistant. Polyester/Cotton blend. Light green.
1965/70 Cpe. Cvt. F/B 79.95
1965/70/ Cpe. Cvt. F/B, Tan Flannel ... 109.95

SEAT UPHOLSTERY

Just like original. The best there is. Available in all original colors. Complete with covered back panels.
1965/68 Standard Seats
2 buckets & rear seat 189.95
2 buckets 134.95
1 bucket 69.95

1965/66 Deluxe Pony Seats

2 buckets & rear seat 244.95
2 buckets 159.95
1 bucket 89.95

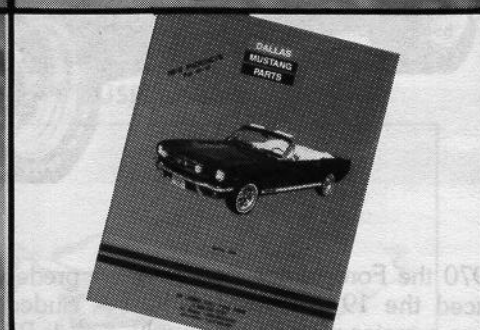
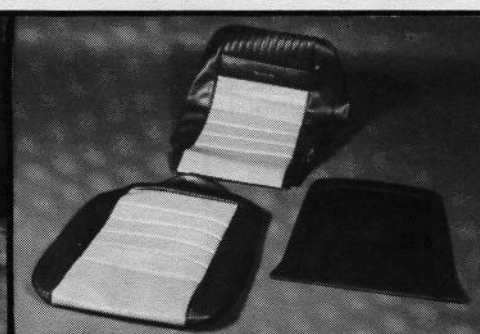
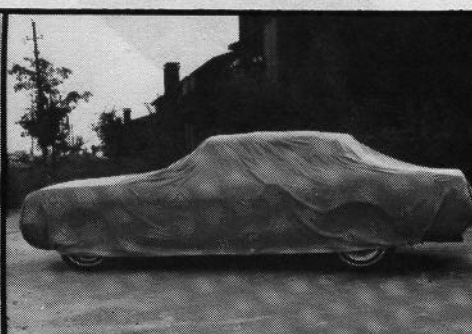
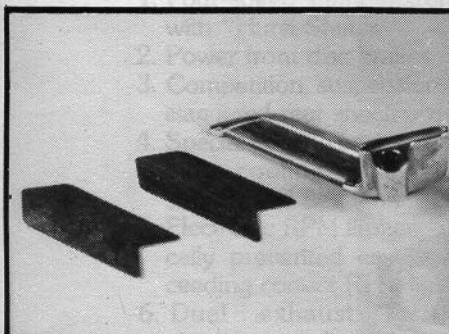

GEAR SHIFT KNOBS

Exact reproduction of original. Compression Molded
1965/68, 3-speed w/base nut
thread size thread 1/2 x 20 29.95
1965/66, 4-speed w/base nut,
concave top 29.95
1967/68, 4-speed w/base nut,
flat top 29.95

SHIFT BOOT CHROME RETAINER

1965/68, Std. Trans. 15.95

MOLDED CARPET

The best available. No cutting or trimming required. Available in Black, Ford Blue, Aqua, Dark Green, Moss Green, Red, Maroon, Dark Brown, Saddle, Emberglow.
1964/68 Cpe. Cvt. F/B 99.50
F/B fold down area 10.00
1969/70, Carpets are 100% Nylon loop pile (same as original)
1969/70 (Specify color)
Cpe. Cvt. or F/B 99.50
F/B fold down area 10.00

NEW PRODUCTS CATALOGUE

Call 1-214-349-0991
to receive your FREE 68-page
DALLAS MUSTANG PARTS
catalogue.

answered by people who *know* Mustangs!

**ORDER TOLL-FREE
1-800-527-1223**

**IN TEXAS, CALL
1-800-442-1047**

**FOR INFORMATION
1-214-349-0991**

Ford's Boss (Part II)

by Carrol Harris Loder

302

351

429



In 1970 the Ford Motor Company introduced the 1971 Boss 351 but there was a major problem of supply and demand — the demand was incredible and the supply seemed to be nil. Automotive magazines were screaming to get their hands on this new Boss for road testing, but orders for paying customers were so backlogged that the dealers were complaining to the Ford headquarters. Ecologists were pressuring government officials for stronger controls on fuel consumption and emission controls. The automotive industry was busy producing cars to appease their critics and were not using their top production plants for Trans-Ams and street "sports cars." This caused the problem of supply and demand of the Boss 351 to increase at even greater speeds than anticipated.

The major standard features of this new Boss had increased greatly over its

predecessors. The exterior features included the following:

1. Black ABS plastic grille in honeycomb design with bright Mustang emblem in the center . . . grille included two sport lamps mounted inboard of the headlights.
2. NASA-type hood with functional scoops and hood locking pins . . . "Ram-Air" decal.
3. Hood painted black or argent.
4. Front hood and fender mouldings were color-keyed to the exterior body color.
5. Lower body side paint treatment.
6. Unique body side tape stripe in black or argent color . . . "Boss 351 Mustang" identification on lower front side panels.
7. Bright chrome hub caps with bright trim rings.
8. Outside color-keyed dual racing mirrors . . . left-hand remote control.
9. Black or argent lower back panel.
10. "Boss 351" identification centered on back panel of deck lid.

The interior features of the Boss 351 included all the features of the SportsRoof plus an instrument panel instrumentation group that included a tachometer, trip odometer, "OIL," "AMP," and "TEMP" gauges. The high-backed bucket seats were not only comfortable but easy to adjust. This interior had the look and feel of a "touch of class," and at the same time it was sporty to match the exterior.

But under the hood was an exciting thing of beauty — the 351 4-V HO engine. This engine included an extra large Autolite four-barrel carburetor with 750 CFM (cubic feet per minute) air flow. The camshaft was designed with longer timing event and higher valve lift and high rpm adjustable mechanical valve lifters. The pistons

MUSTANG TIMES

were of high strength extruded aluminum with pop-up domes. The connecting rods were magnafluxed with high strength nuts and bolts. The crankshaft received special handling, inspection and hardness treatment. The compression ratio of 11.00 to 1 required the use of premium fuel. Immediately, racing enthusiasts wanted to make this Boss 351 engine faster.

It is also important to reveal some of the many functional features of the new Boss. The designers of Ford worked hard and diligently to make this Mustang a truly functional operating machine.

1. Four-speed manual transmission with "Hurst Shifter."
2. Power front disc brakes.
3. Competition suspension included staggered rear shock absorbers.
4. Special cooling package. (Included extra-cooling radiator, radiator shroud and flex fan.)
5. Electronic RPM limiter. (Automatically prevented engine from exceeding correct RPM limits.)
6. Dual exhaust system with aluminum and stainless steel muffler components.
7. 80-ampere battery.
8. 3.91 ratio locking axle.
9. F60 x 15 belted bias-ply BSW tires with raised white letters (also a space saver spare tire).

FRONT SUSPENSION

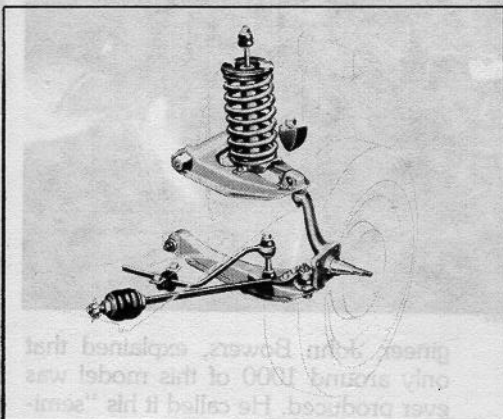

PLATFORM CONSTRUCTION

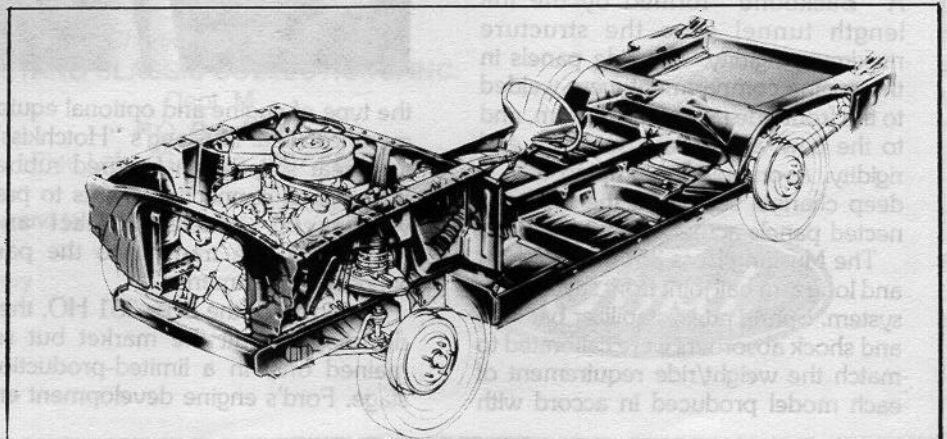

351-4V HO ENGINE SPECIFICATIONS

Type	90° V, 8 cyl., OHV
Displacement (Cubic Inches)	351
Bore and Stroke (Inches)	4.00 x 3.50
Bore/Stroke Ratio	1.14 to 1
Bore Spacing (Inches)	4.38
Rod Length (Inches)	5.78
Maximum Horsepower @ RPM	330 @ 5400*
Maximum Torque @ RPM	370 @ 4000
Compression Ratio	11.0:1 Nom., 11.7:1 Max. 10.3:1 Min.
Piston Compression Height (Inches)	1.631
Carburetor	Autolite, 4-Venturi, Spread Bore, 750 CFM
Fuel	Premium
Valve Train	Mechanical
Valve Lash (Cold)	.022 Intake and Exhaust
Rocker Arm Ratio	1.73
Valve Lift (Inches)	.491 Intake and Exhaust
Cam Lift @ Timing Points	.010 Open and Closed
Valve Event	324° Intake and Exhaust
Exhaust Opens	102° BBC
Exhaust Closes	42° ATC
Intake Opens	50° BTC
Intake Closes	94° ABC
Intake Valve Diameter (Inches)	2.195
Exhaust Valve Diameter (Inches)	1.714

*Dynamometer Rated

REAR SUSPENSION

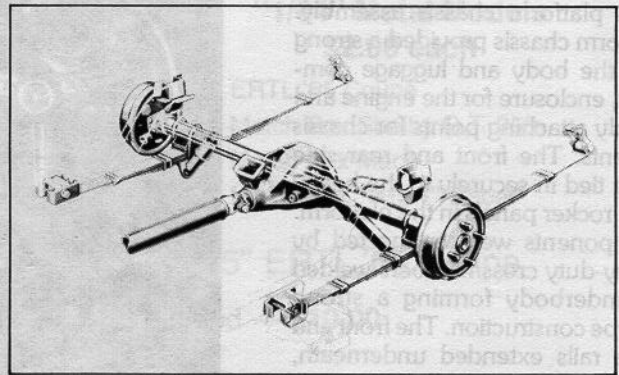



Mustang's unit-built body design included a platform chassis assembly. The platform chassis provided a strong base for the body and luggage compartment, enclosure for the engine and underbody attaching points for chassis components. The front and rear side rails were tied in securely to the heavy boxed-in rocker panels in the platform. The components were connected by five heavy-duty crossmembers welded to the underbody forming a strong ladder-type construction. The front and rear side rails extended underneath, and were also welded to the floor pan. A "Backbone" formed by the full length tunnel gave the structure maximum rigidity. The side panels in the engine compartment were welded to the front side rails at the bottom, and to the cowl at the rear, for front end rigidity. A one-piece stamping with a deep channel section at the top connected panels across the front.

The Mustang Boss 351 used a short and long arm ball joint front suspension system. Spring rates, stabilizer bar size, and shock absorbers were calibrated to match the weight/ride requirement of each model produced in accord with



the type of engine and optional equipment installed. Mustang's "Hotchkiss" type rear suspension featured rubber bushings at connection points to prevent metal-to-metal contact and minimize noise transfer to the passenger compartment.

In mid 1972 the Boss 351 HO, then de-smogged, hit the market but remained only in a limited-production stage. Ford's engine development en-

gineer, John Bowers, explained that only around 1000 of this model was ever produced. He called it his "semi-performance" Boss. Ecology was finally catching up to Ford's Boss. **MT**

Information was compiled from *Bosses 302, 351, 429, March 1971 of Car and Driver*, and *Mustang, The Complete History of America's Pioneer Ponycar*.

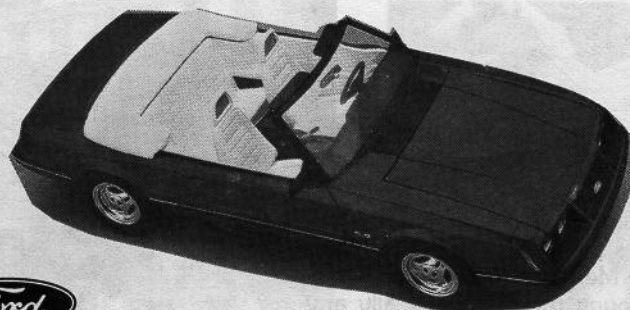

'64 1/2 - '83 MUSTANG "ANNIVERSARY SALE"

(All prices include tax, freight, prep., insurance & fee's in U.S.)*

New Arrival! A.M.T. "1/16" (Large Scale) '64 1/2 Coupe — \$15.00

**"1/25" Plastic Kits
\$6.25 each**

- A.M.T. '66 Coupe
- A.M.T. '73 Mach I
- Jo-Han Mach I Funny Car
- M.P.C. '83 G.T. Coupe
- Revell '83 Convertible
- M.P.C. Pro Street Mustang II

**"1/24" Monogram Plastic Kits
\$6.50 each**

- '70 Boss
- '83 G.T. Convertible
- Miller IMSA Racer
- Ford Motorsport IMSA Racer



Cobra Roadsters (Kits)

- M.P.C. "1/16" 427 Cobra — **\$19.00**
- A.M.T. "1/25" Cobra — **\$6.25**

**"1/64" Metal Models
\$2.00 each**

- ERTL '65 Coupe
- Match Box Shelby G.T. 350
- Match Box Mach I
- Match Box "IMSA" Racer

Limited Supply — While They Last! "1/25" ERTL '65 Coupe

Metal Model with Opening Doors and Hood — \$10.00

— More Plastic Kits —

- A.M.T. "1/43" '69 Mach I — **\$3.50**
- Monogram "1/32" Boss — **\$4.00**

Send Check/Money Order To:
MUSTANG CLASSIC COLLECTIONS, INC.

Dept. M
P.O. Box 539
Pine Lake, Georgia 30072-0539

Shipped **U.P.S.** — Please include street address and telephone number
Allow 3-4 weeks delivery. U.S. Funds Only.

*Canadian Orders — Add 25% for air mail delivery
Foreign Orders — Add 50% for air mail delivery



The Mid-South Nationals

The Mustangs of Memphis hosted the first Mid-South National show the first weekend of June. Clark Welborn, show chairman, along with President Ed Xiques planned long and hard to make the Memphis show a little different. Although there is not really any good way to dress up a Mustang show, you can make visitors aware of the two or three main attractions in the local area. The show packets contained information on Beale Street, the street that gave birth to the blues featuring music of all kinds with shops and clubs by the dozens along the Mississippi River, Mudd Island, the entertainment center smack dab in the middle of the river featuring headline entertainment and, of course, tours of Graceland, home of the late Elvis Presley.

Thursday was a leisurely day with not much going on except for a few early arrivals and the group making last minute preparations for the show. Seventy-seven cars were preregistered and another 31 showed up for a total of 108 show quality cars for the judges to



Memphis, Tennessee
Hosted by Mustangs of Memphis

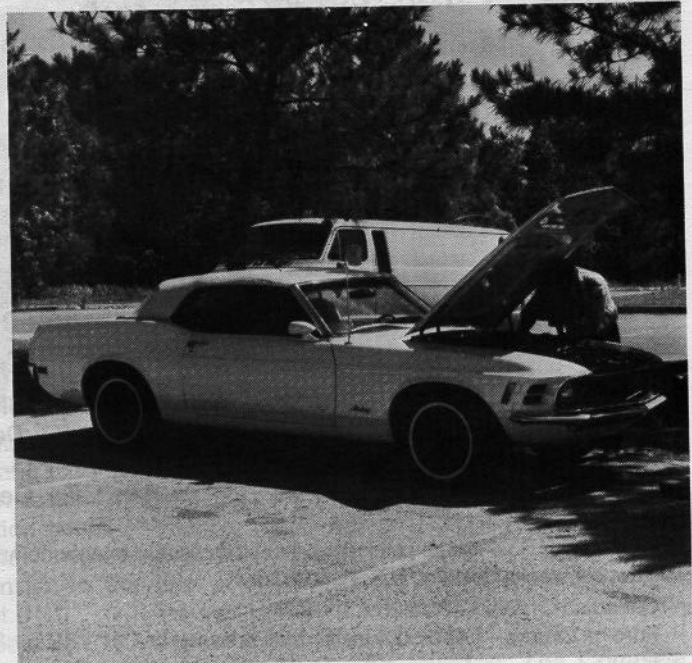

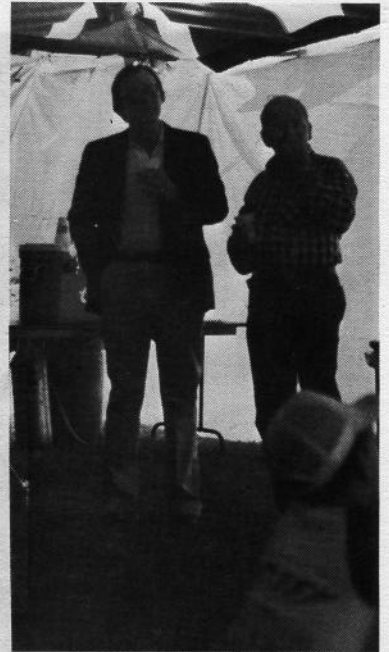

look at. Friday was a bit more hectic with more and more cars coming in the closer it got to 5 o'clock. At 5:00 p.m. on Friday there was a hospitality party in a huge tent set up at the hotel. The hospitality party was sponsored by Ford Motor Company and drew quite a crowd. At the party the Memphis District Ford people were introduced along with George Lowe who was down from Detroit and would be the featured speaker at the banquet on Saturday evening. Clark Welborn traveled to Detroit earlier in the year to get Ford interested in their show and was very successful. Also not to be left out, Dobbs Ford supplied the lot behind their dealership for the show. As a lot of us know, finding adequate room to hold a show is getting harder and harder each year. So far this year the people from Ford have been very cooperative and supportive of the two Nationals we have had.





Saturday the show shifted into high gear and by noon all 108 cars were in place and the teams of judges were hard at work under the hot sun looking at each Mustang. With temperatures in the high 80's many a Mustanger took home a sunburn. The cars were some of the finest examples anywhere. Saturday afternoon Ditzler Paint Company held a seminar on car finishes and answered many questions and showed off the latest products in automobile finishes. Of course, the Mustang vendors were out in force with Mr. G's, JJ's Mustang, Auto Custom Carpets, Vintage Motors, Vintage Tee's, Mustang Classic Collections, MCA Accessories, Norton's Auto Restorations, Clements Enterprises and a few more were there selling their wares. The cars came from Wisconsin, New Jersey, Illinois, Tennessee, Georgia, Arkansas, Mississippi, Florida and a dozen other states.

Saturday evening's banquet was a casual affair with barbeque, ribs, cole slaw, baked beans and more for everyone to eat. George Lowe spoke on the marketing of Mustangs from what is believed to be the first TV commercials shown before Mustangs debut through the 1973 commercials with a few Mustang II and current commercials thrown in for comparison. George played the part of the "color man"

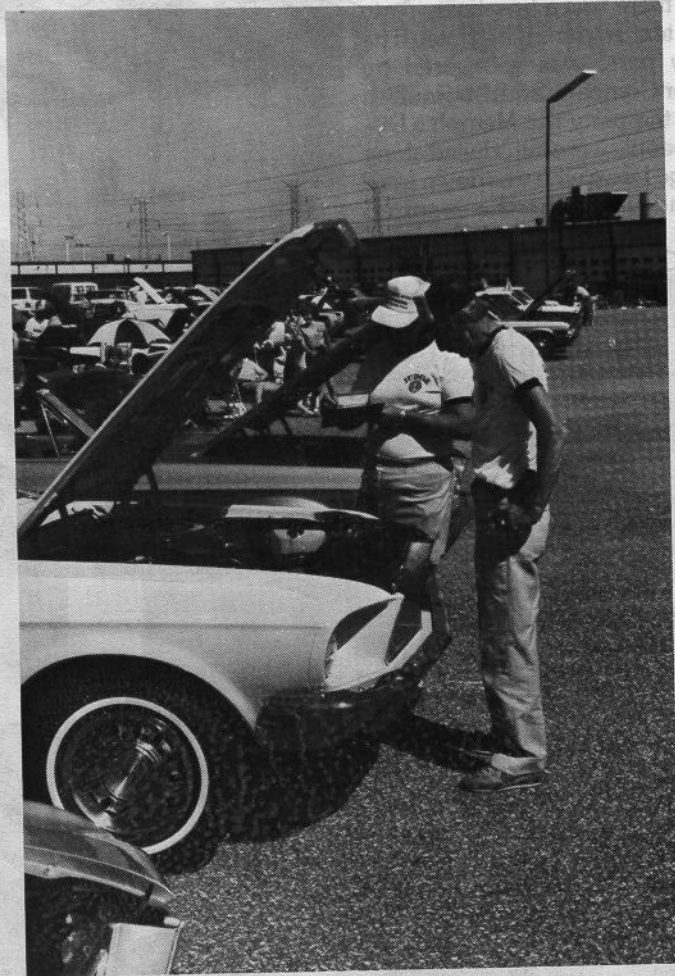

on Friday
 in a huge
 hospitality
 Ford Motor
 crowd. At
 first Ford p
 with Georg
 Detroit an
 speaker at
 evening.

while we watched the commercials on two closed circuit TV's set up under the huge tent. Some of the commercials used actors and actresses who were little known then but today are seen on weekly TV series. After dinner and the commercial presentation came the moment everyone was waiting for, the awards presentation including a special award from Ditzler paint. The awards are walnut plaques that were lazer engraved and are very attractive. Mike Tankersley from Alabama won the Ditzler award with his multi-colored modified fastback.

Another National is now history with our congratulations going to the Mustangs of Memphis group for a great effort.

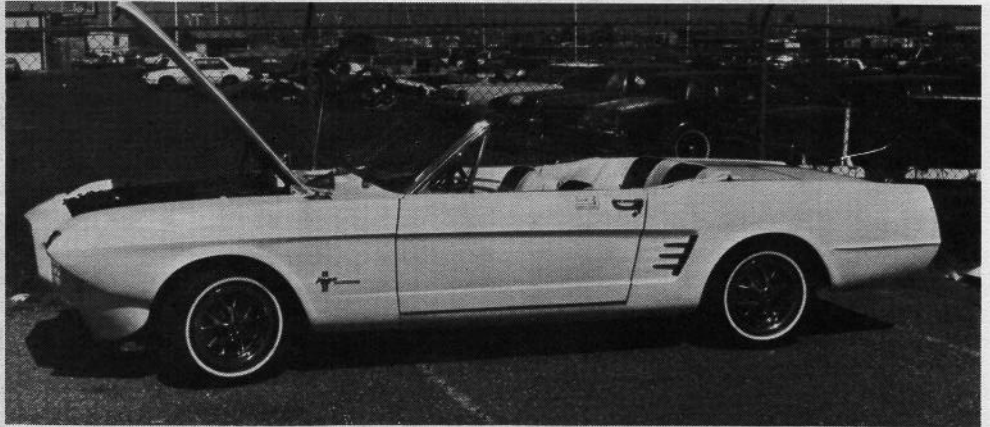

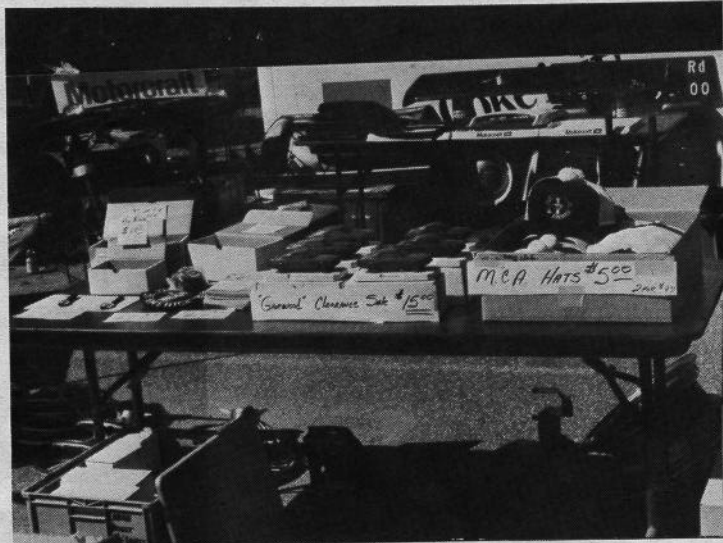

New Products

New Products

New from New Castle Battery is the reproduction Sta-ful Autolite battery that came as original equipment in all the Mustangs. This is a quality battery utilizing the latest technology in the original Autolite case. The battery comes with a four-year warranty and is a welcome addition to the ever growing line of reproduction parts. Bill Dillard, National Head Judge, has inspected this product and approved it for use in MCA-sponsored shows. For more information see their ad.

New from Gelsi's Mustang World is a complete line of interior paints; seven colors plus Ford blue for your engine and a semi-flat black for under the hood. Check with Gelsi's Mustang World for particular colors.



New from Salter's Classic Autos is a new trick for preserving your natural parts including exhaust parts; a natural metal paint that holds up very well on hood hinges, exhaust manifolds, and pipes and any place else that needs to be natural. We have seen some of this product on some show cars and it is very difficult to determine whether or not it is correct. Get yours from Salter's Classic Autos, 235 Spruce Street, Pace, FL 32570.



OPEN THE DOOR



If You Don't
See What You
Want Here...
Call, We
Probably Have
It!

**TO AN ENTIRE WORLD OF
MUSTANG PARTS AND ACCESSORIES**

SPECIALIZING IN THE MANUFACTURING OF **DOOR PANEL SKINS**

- ★ 1965, 1966 Pony Molded Vinyl Door Panel Skins pr. **\$114.95**
 - ★ 1967 Deluxe Molded Vinyl Door Panel Skins pr. **\$114.95**
 - ★ 1969 and 1970 Deluxe Molded Vinyl Door Panel Skins pr. **\$249.95**
 - ★ 1971 thru 1973 Deluxe Molded Vinyl Door Panel Skins pr. **\$249.95**
- Price includes mounting of skin on your present panel.*
- ★ 1965 and 1966 Convertible or H/T Kick Panels pr. **\$ 30.00**
 - ★ 1964, 1965 and 1966 Molded Carpet Sets pr. **\$110.00**
 - Rear Area for F/B ea. **\$ 20.00**

*Also Carry Complete Line Of
Upholstery 65-68*

NEW ITEM!

Complete 65-66 pony door panels less stainless steel trim, including cup & pad.
All Colors Available pr. **\$164.95**

NEW ITEM
Complete 67 Door Panels,
Less Hardware

IN STOCK

Convertible Tops 65-73 • All Rubber Seals 65-73 • N.O.S. Chrome Parts 65-73
• Rechromed Parts 65-73 • Sheet Metal 65-73 • Hard To Find Used Parts •

Send For FREE Parts List

FOR ORDERS CALL: 1-800-327-3640 Outside Fla.

Bill B. Heshner

315 South Hopkins
Titusville, Florida 32780

305/267-4175

8:30 A.M. to 5:00 P.M.
Monday thru Friday



Mustang City

5613 ELLIOTT REEDER ROAD • FORT WORTH, TEXAS 76117-6091

ORDERING ONLY • 1-800-433-7850

FOR INFORMATION • 1-817-831-3501 - 1-817-838-3131

AL 101	67 Brushed Aluminum Console Insert	\$10.00
AL 102	67 Brushed Aluminum Dash Kit, Non Air (6 pcs) .	\$89.95
AL 103	67 Brushed Aluminum Dash Kit, W/Air (7 pcs)...	\$69.95
AL 106	67 Brushed Aluminum Door Panel Insert (2)	\$69.95
UP 101	65-66 Cardboard Backs	\$9.95
UP 111	65-66 Pony Door Repair Skins	\$99.95
UP 114	67 Deluxe Door Panel Repair Skins	\$99.95
HO 118	67 Horn Ring	\$13.95
HO 101	68 Horn Panel Button (Painted) EA.....	\$3.95
HW 312	Air Breather Wing Nut (6 cyl.)	\$2.40
HW 311	Air Breather Wing Nut (V-8)	\$1.20
HW 301	Battery Tray Mounting Kit	\$3.90
HW 301A	65-66 Battery Hold Down Bolt, Nut, and Washer....	\$1.50
HW 301D	65-73 Battery Hold Down Bolt and Nut.....	\$1.85
HW 395	Fender To Cowl Nuts (2)	\$3.00
HW 305	Fender Bolt U-Nuts (12)	\$6.00
HW 304B	Fender Bolts,Black With Star Washers (12 ea.)	\$8.00
HW 304A	Fender Bolts,Cadmium W/Star Washers (12 ea.) .	\$10.00
HW 304	Fender Bolts,Cadmium W/Loose Washers (12 ea.) .	\$8.00
AC 110	65-66 Woodgrain Kit With Pistol Grips	\$39.95
AC 112	65-66 Woodgrain Insert For Pistol Grip Handles ...	\$4.95
AC 111	68 Woodgrain Kit (Non Air)	\$39.95
AC 113	68 Woodgrain Kit (W/Air)	\$29.95
AC 115	69 Woodgrain Radio Bezel Insert	\$15.00
HW 552	65 RallyPac Mounting Bracket W/Rubber Seal	\$8.50
HW 554A	65 RallyPac Clock Lens	\$12.50
HW 554B	65 RallyPac Tach Lens	\$13.50
HW 558	66 RallyPac Wiring Channel Guide	\$15.00
HW 555A	66 RallyPac Clock Lens	\$12.50
HW 555B	66 RallyPac Tach Lens	\$12.50
HW 556	66 RallyPac Ring (New)	\$12.50
HW 557	66 RallyPac Dial, Painted (New)	\$5.00
HW 488	Air Breather Hose Clamps (2)	\$1.00
HW 590	Gas Filler Hose Clamps (2)	\$5.00
HW 487	Gas Line Hose Clamps (2)	\$1.00
HW 482	Radiator Hose Clamps,6 Cyl. (10)	\$15.00
HW 483	Radiator Hose Clamps, V-8 (10)	\$15.00
HW 484	Radiator Hose Clamps, Big Block (10)	\$15.00
HW 485	Radiator Hose Clamps, Double Wire (10)	\$15.00
HW 331	65-68 Bumper Bolt Kit (Correct Ones)	\$13.00
HW 331A	69-70 Bumper Bolt Kit	\$13.00
HW 406	65-66 Windshield Washer Tubing Kit	\$6.00
HW 407	67 Windshield Washer Tubing Kit	\$6.00
HW 408	68 Windshield Washer Tubing Kit	\$6.00
HW 408A	69-70 Windshield Washer Tubing Kit W/Tee	\$6.00
HW 101	66-67 Air Conditioner Drain Hose	\$8.50
RA 102	Radiator 2-Core (Exchange)	\$124.95
RA 103	Radiator 3-Core (Exchange)	\$149.95
RA 104	Radiator, Desert Cooler 4-Core (Exchange).....	\$174.95
BR 101	Fan Shroud Bracket 2-Core	\$3.00
BR 102	Fan Shroud Bracket 3-Core	\$4.00
BR 103	Fan Shroud Bracket Desert Cooler 4-Core	\$4.00
HW 416	65-66 Fan Shroud Brackets 2-Core (4)	\$12.00
HW 417	65-66 Fan Shroud Brackets 3-Core (4)	\$16.00
HW 418	65-66 Fan Shroud Brackets 4-Core (4)	\$16.00
Hw 398	65 Grill Brackets (2)	\$6.00
HW 399	65-66 Bumper Guard Brackets (2)	\$6.00
HW 507	Cobra Air Cleaner Mounting Bracket Kit	\$9.95
HW 396	65-66 Cowl Weatherstrip Bracket Kit (2)	\$5.90
HW 372	65-67 Door Brackets Pony or Deluxe (2)	\$7.50
HW 379	Pony Door Handle Extension Kit (2)	\$12.95
HW 504	Deluxe Interior Trim Screw Kit (Pony)	\$10.00
HW 502	Interior Trim Screw Kit (Coupe)	\$10.00
HW 501	Interior Trim Screw Kit (Conv.)	\$10.00
HW 503	Interior Trim Screw Kit (F/B)	\$11.00
HW 492	Standard Shift Repair Kit (3 Speed)	\$10.95
HW 493	Standard Shift Repair Kit (4 Speed)	\$9.95
HW 447A	Automatic Shift Repair Kit	\$2.10
BR 104	65-66 Console Shift Plate Assembly	\$35.00
HW 421	67-68 Automatic Shifter Conversion Kit, From Without Console To With Console	\$12.95
HW 345	66 Spare Tire J-Bolt (9"), Nut, & Plate	\$7.50
HW 344A	64-65 Spare Tire Bolt	\$3.00
HW 344	64-65 Spare Tire Bolt, Wing Nut, & Plate	\$7.50
HW 346A	66-68 Spare Tire J-Bolt (9 1/2")	\$3.35
HW 346	66-68 Spare Tire J-Bolt (9 1/2"), Nut, & Plate ..	\$7.50
HW 400	67-68 Hood Bumper (Front)	\$8.00
HW 401	67-68 Hood Bumper (Rear)	\$8.50
HW 402	69-70 Hood Bumper	\$8.00
HW 413	License Tag Bumper (Front)	\$6.00
HW 414	License Tag Bumpers (2)	\$1.20
HW 438	65-66 Rear Folding Seat Bumpers (2)	\$1.20
HW 437	Ash Tray Bumpers (2)	\$1.20
HW 431A	65-66 Deck Lid Bumpers (2)	\$2.50
HW 431B	67-68 Deck Lid Bumpers (2)	\$2.50
HW 438	Glove Box Bumpers (2)	\$1.20
HW 400	65-66 Hood Bumper	\$7.75
HW 429	65-68 Door Bumpers (4)	\$3.00

And Much More !

Discounts
10% Discount to Mustang Club Members.
Additional 5% Discount to MCA Members.
Please Give Membership No. When Ordering.

Order Information
VISA, Mastercard, COD. Add 10% Handling and Shipping Charges (Min. \$2.00).
Free Shipping on Prepaid Orders over \$200

REGIONAL GROUP NEWS

Mustelby Mustang Club

The Mustelby Mustang Club had its regular monthly meeting on May 20, 1984 at 2:00 p.m. Richard Graham, president, opened the meeting. We had six members and one guest present.

Doug Miller from The American Cancer Society met with us again and we discussed several things concerning our MUSTANG ROUND-UP that will be coming up on July 14. We do have some things of great interest to all who will be wanting to participate in our Round-up. We want everyone to understand that this is a ROUND-UP and any Mustang in any condition is wanted and welcomed. Don't think it has to be show quality. We just want all the Mustangs for 1964½ thru 1984 to be there.

Dash plaques will be given to all participants. Also, the first 50 registrations will receive a beautiful wooden plaque. Thanks to Jeans Carpet & Tile Shop, we will have 51 TROPHIES to give away. Also we have longest distance traveled trophy and Magic City Ford in Roanoke, VA will give away as their choice the trophy donated by Mustang Club of America. We will also be having all kinds of door prizes.

So I urge all of you to get in touch with us as quick as possible. Registration will be \$5.00 until June 1. June 1 thru July 14 it will be \$10.00. All proceeds will go to The American Cancer Society. We will also have raffle tickets for an AM-FM Cassette Stereo and two Pioneer speakers to give away.

Let's make this Mustang Twentieth Anniversary Round-up the best that Roanoke, VA has ever seen.

Again, I want to thank *Magic City Ford* for their generous donation and for having this Round-up on their lot. Thanks to Mustang Club of America for their donation of a trophy, Jeans Carpet & Tile Shop for their donation of 51 trophies, The American Cancer Society for all their help and for all in the Mustelby Mustang Club for the hard work of getting this together.

Will be looking forward to seeing everyone in Roanoke, VA on July 14.

Howard Lee Nichols
National Director

CLOCK REPAIR

Enjoy a clock that looks and works like new. Send your Mustang clock to us for the finest clock repair service. Most clocks \$28 plus \$2 shipping. Mustang clocks available for sale.

Clock guaranteed for one year.

Pennsylvania Mustang Parts

P.O. Box 321
Feasterville, PA 19047

CLASSIC
INSURANCE AGENCY

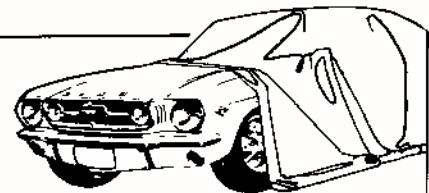

Announces

"Blanket Protection"

A full stated amount insurance program designed to meet the needs of Mustang owners, and all collectors, including those specializing in late model and high performance automobiles.

Classic's new "BLANKET PROTECTION" program is affordably priced insurance that includes **LIABILITY** (in most states) and full stated amount coverage for fire, theft and collision.

If you drive your special car 2500 miles or less a year and you would like more information about this coverage call us toll free at:

(800) 631-1363
In Georgia: (404) 955-8787

Classic Insurance Agency • 1 Perimeter Way, N.W. • Atlanta, GA 30339

First Pennsylvania Mustang Club

Spring in PA found many of the member's getting anxious to get their cars into action. Car shows usually run from around the first weekend in May until October.

First PA participated in a car display at Emmaus Ford, Emmaus, PA on May 12. The dealership wanted to promote the 20th Anniversary Mustang and put several of our older Mustangs in their display window.

Elections were held at our May meeting and the following were elected to Officer's positions: Dale Bowes, Hatboro-president; Rich Caka, Easton-vice-president; Cliff Harze, Zionsville-treasurer; Linda Bowes, Hatboro-secretary. Also elected was Ken Floyd, Warminster to the one Board opening.

Upcoming events is our second annual road rally in June, our annual car show and flea market in August and a weekend tour to West Point, NY in the fall.

Linda Bowes
Secretary

Custom Triple Chrome Plating

Superior Quality On All Metals

Nickel • Copper • Chrome • Gold • Brass

• Excellent Workmanship

• Fast Service



Write or Call for information



SWIRIN PLATING SERVICE

535 Indian Road

Wayne, NJ 07470

Phone: (201) 839-6580

Rio Grande Mustang Club

To celebrate "A Legend Turns Twenty," the RGMC joined with Albuquerque's Richardson Ford at the dealership on the 21st of April. Some 15 Mustangs in the '64½-70 era from the club were on hand for public display. Richardson Ford made the legend posters available to each club member. Their showroom floor highlighted three of the '84½ commemorative models, and during the day, two of those were purchased by RGMC members. The Rio Grande Mustang Club now has three each restored original edition '64½ ponies and three each '84½ commemorative editions.



Bob Miller

MUSTANG & FORD



- ★ Exact reproduction
- ★ Authentic replacement for 1962-1973 Ford & 1964½-1973 Mustang
- ★ Exceeds original capacity
- ★ Master Charge, Visa, or Personal Check. NO COD
- ★ Top script painted red
- ★ Shipped "Damp-Dri" by UPS
- ★ PA residents add 6% tax
- ★ 4 year warranty
- ★ Exact reproduction red vent caps
- ★ Warranty tag reproduced to exact detail w/serial number

\$96.00
Plus \$8.00

(script painted for display purposes only)

GROUP 24F

Shipping & Handling

NEW CASTLE BATTERY MFG. CO.

P.O. BOX 5040, - NEW CASTLE, PA 16105
412-658-5501

USED MUSTANG PARTS

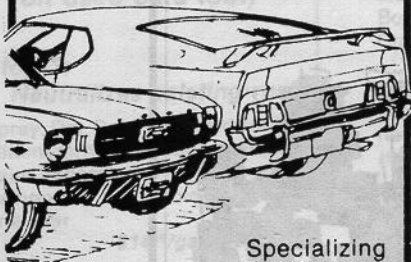

Specializing
In 1964½-1978

**SEND FOR OUR
FREE CATALOG!**

MUSTANG PARTS CORRAL OF TEXAS

P.O. Box 210524
Dallas, TX 75211
214-296-0207

Mississippi Coast Mustang Club

The regular monthly meeting of the Mississippi Coast Mustang Club was held on Sunday, April 29, 1984.

Ray Parrish has moved his shop. The phone number is still the same so you may call for directions.

For those of you who missed the April 14 Pensacola show — we had a great time. Three of our members had cars entered, Ed Napper, Richard Carbo, and Bill Sowell and they all took 2nd place in their category. Congratulations!

Steve Burns reported that on the weekend of May 26 the Corvette Club is having a car show at the coliseum. And on Sunday, May 27 they are having an auto cross which will be open to all cars. There will be an entry fee for the auto cross. Come on down and join the fun!

It has been suggested that one Sunday all the clubs meet somewhere to help promote their clubs and have a good time. Also suggested was to make our August picnic at the West Side Community Center an annual affair. These are pending.

We welcomed four guests to our meeting: Chad Mitchell, 1966; Paul Wally, 2-1965's & 1968; Eric Heinrich, 1967 & 1968 and Cecil Scoggins, 1973.

Don't forget our next meeting is May 20. We will meet at the Lighthouse at 1:00 p.m. and have a "short" meeting and then leave promptly at 1:30 p.m. We will be caravanning with the Camaro Club and they have gotten us a police escort all the way to the West Side Community Center. So bring along a picnic lunch and come join us and let's beat those Camaro's and show them who is **BEST!!!**

Billie Sowell
Secretary

Georgia Regional Mustang Club of America

The April, 1984 meeting was called to order by our vice-president, Tracy Harrell and Lee Mathias of the Shelby Club. The April meeting brought the largest turn out of members this year. Show committees were set-up and chairpersons appointed.

The Prom Queen and her court was selected. Due to a tie, we have two Prom Queens, one from the Georgia Regional Mustang Club and one from the Shelby Club. The Georgia Regional MCA queen is Miss Amy Wilson, daughter of Jim and Brenda Wilson. The Shelby queen is Miss Shanna Rae Skone, daughter of Mr. & Mrs. Brian Skone. The queen's court consists of the following: Shanna Fernandez, daughter of Al and Gail Fernandez; Erica Lasky, daughter of Kitty Lasky, Kari Stephens, granddaughter of Sara and John South; Christine Young, daughter of Joe and Judy Young.

Diane Pfeifer, Capitol recording star, and her band will entertain us at the "Sock Hop" on Saturday night, May 5, 1984.

Ruth Ann Winchester
Secretary

First Piedmont Regional Group

The First Piedmont Regional Group held its 5th Annual Mustang Rally and Swap Meet on Saturday, May 5th. The show was sponsored by J.E.B. Stuart Ford-Mercury at their dealership in Stuart, VA.

There were 45 cars entered in 12 different classes. Winners were:

65-66 coupe: Steven Alley, Lawsonville, NC
67-68 coupe: Virgil Klaiber, Coeburn, VA
69-73 coupe: Allan Cornett, Collinsville, VA
65-66 Fastback: Marion Hall, Lawsonville, NC
67-68 Fastback: Walter Durocker, Roanoke, VA
69-73 Fastback: Cathy Poole, Brookneal, VA
65-66 Convertible: Bobby Owens, Lawsonville, NC
67-68 Convertible: Albert Cardwell, Stoneville, NC
69-73 Convertible: Dean Goad, Stuart, VA
Boss: Dean Goad, Stuart, VA
Shelby: Dick and Ellie Schubert, Tazewell, VA
Best of Show: Dick and Ellie Schubert, Tazewell, VA
Modified: Charles E. Nunley, Roanoke, VA

Eddie Harbour
Secretary

Catalog \$2.00

Mustang of Chicago™

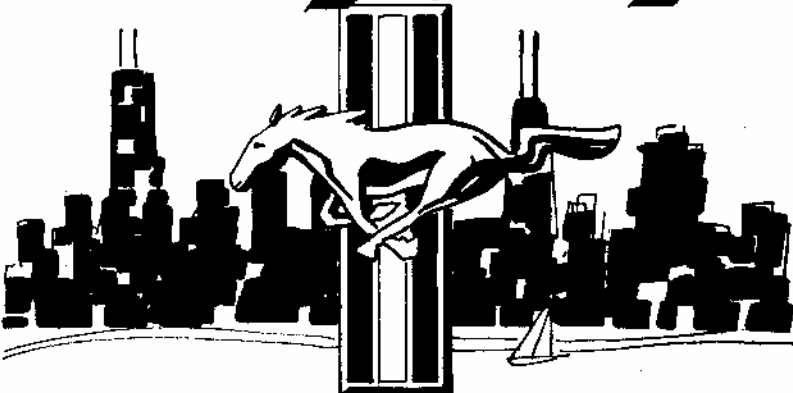

WE CARRY A COMPLETE LINE OF ---

- 65 thru 72 73 Mustang parts
- 65 thru 70 Shelby parts
- 32 thru 56 Ford parts

DIVISION OF
DELUXE FORD PARTS LTD.

227 E. JAMES UNIT #6 BENSENVILLE, IL 60106
(312) 860-7077

CLASSIFIEDS

CARS FOR SALE

1964½ Mustang Convertible, 260, auto, PS, PB, PT, console, all original. Earliest known San Jose, CA Production Mustang, assembled July 14, 1964, 5R08F100045, Number 45! (See December issue of *Times*), \$5500. Tom (818) 348-1139 CA.

1964½ Mustang Coupe, 289, 4V, D code motor, auto, PS, air, new black paint, white vinyl top, luggage rack, Palomino interior. 2nd Place Grand National 1981. (704) 684-5064.

1964½ Mustang Convertible, 260, 3 spd., new carpet, new interior, good top. Good condition. \$4895. 1968 Mustang Fastback, V8, auto, AC, PS, white w/2-tone blue deluxe interior. Good condition \$2995. Paul Millsap, PO Box 25, Jasper, GA 30143. (404) 692-5866 after 7 pm.

1965 Mustang Coupe, red with white vinyl roof, 3 spd., completely restored, mint condition, \$5500. (301) 531-3426 or (301) 992-0016 Fred.

1965 Mustang Coupe, 6 cyl., 3 spd., AC. 5R07T172840 65A0D609A7531. Red (should be light blue) with white interior, very original, no floor pan rust. Great project car. \$2000. (409) 846-7731.

1966 Mustang convertible, Georgia car, 90% restored, \$5200. (313) 626-1226. Call in evenings.



**NOW AVAILABLE
1964-1968 MUSTANG
CONVERTIBLE TOP
SIDE-RAIL WEATHERSTRIP
NOW SHIPPING...**

Flawless, Compression Molded Convertible Side-Rail Weatherstrips. A Satisfaction Guaranteed Alternative to UGLY, CRACKED, and ROTTED Originals or other poor reproductions. Protects Expensive Restored Interiors and Prevents Annoying Drafts.

FEATURES...

- Compression Molded in Handmade molds using Durable E.P.D.M. stock • Guaranteed better than Original Fit and Finish • Precision molded cornerpieces (DOGLEGS) that not only fit better than the original, but also look better • Full length molded-in steel backbone with welded studs same as original • Do not confuse this NEW product with the cheaper extrusion type reproduction • These are proven quality parts, manufactured by a company with many years experience specializing in convertible top weatherstrip. Our parts have been installed on many show winning cars.

**\$159.95 COMPLETE SET
ADD \$4.00 SHIPPING
Make Checks Payable To:
DAVE McBRIDE
C/O CALIFORNIA CLASSICS
645 E. McGilincy Lane
Campbell, CA 95008
(408) 377-2324**

1968 Mustang GT convertibles, (1) Red deluxe show winner, 289, 3 spd., AC stereo, \$9350. (2) straight, rust free, original 302, 4 spd., PT., PB, stereo. Need only paint and interior \$4800. Both built 1/23/68, \$13,500 takes all. Dick Cromie. (714) 861-8658 Los Angeles.

1968 Mustang Coupe, 289, V8, auto, rustless Utah body, floors and frame excellent, brand new rug and head liner still in box. \$1300 neg. (607) 724-2936 Binghamton, NY.

1968 Mustang GT Fastback, 428 CJ. "Ford's Forgotten Hero." Serial number 8F02R192126, ram air, 4 spd., Traction Lok rear end, power disc brakes, \$8000. (314) 822-0830 after 5 CST.

1968 Mustang, 289, V8, PS, PB, AC, lime green/white top. green interior, 63,000 miles. Original owner. Runs and looks great. \$4700. E. C. Corra, 200 Lake Blvd., Buffalo Grove, IL 60090. (312) 459-8966.

1972 Mustang Coupe, 302, V8, AC, stereo/tape, 2nd owner, 65,000 miles. Golden brown/no rust, new vinyl top, interior immaculate, \$2500. (215) 539-5351 Norristown, PA.

CARS WANTED

Wanted 65-70 Shelby or Mustang Fastback, 8 cyl., factory air in original/very good condition. Mach 1 or GT preferred. Trade 83 Mazda RX7-65 or cash. Send picture/description to Mark Snailer, 7016 Van Natha Ln., Ft. Worth, TX 76112. (817) 451-2304 evenings.

Wanted 1965/66 Hi Performance K-GT convertible. Not bargain hunting. Looking for right combination of red, black, or white with pony interior. Original data plate. Any condition considered. Private party. Ed (415) 349-7244

Wanted 1969-73 Mustang convertible, prefer well equipped, clean car near PA area. Bob Feld, 7502 Manchester Rd., Melrose Park, PA 19126. (215) 886-1160 days.

New RUST Prevention System REALLY WORKS (on used cars too!)

**Rustop-3:
Neutralizes existing rust.**

- Spray, Dip, Brush on, inside or out.
- Minimum/no residue; increases paint adhesion.
- Temporary rust protection up to one year.

\$14⁹⁵/gal. Plus U.P.S.

**Rustop-40:
Prevents Rust 5-10 Years
(Replaces Undercoating)**

- Thin coating dries hard and clear.
- Highly polar — Bonds to metal.
- Apply with any paint equipment, brush or spray.
- No fillers added to shrink or crack.
- Easily removed.
- Passes ASTM 3000 hr. salt/fog test.

\$23⁵⁰/gal. Plus U.P.S.

Hawk Laboratories
Box 112, Sta. 27
Lakewood, CO 80215

Visa/MC
Welcome
303-447-0239

C.A.R. DISTRIBUTORS

12375 New Holland St., Holland, MI 49423
(616) 399-6783



NEW!
71-73 Rear Wheel Well Repair Panel \$80.00

Available at Most Local Distributors



69-70 Rear Wheel Well Repair Panel
Fits FB, Coupe, Conv.
\$80.00

Add 10% Shipping, U.S.A.



65/66 3-pronged wheel spinners w/blue centers ea. \$24.00
Set of 4 \$95.00
W/O centers \$16.00
Centers alone ea. \$10.00



69-70 Grille Rivets
Set of 5 **\$2.50**

West Michigan Headquarters For Mustang; Model A & Early Ford Parts

PARTS FOR SALE

Mustang Parts D2ZZ 6340110-A rear deck, 71-73 fastback, \$75. D0ZZ 16138A core support 70, NOS \$50. D1ZZ 6510218A RT. front frame member outer, NOS \$50. C6ZZ6582A RT valve cover 289 HIPO chrome, NOS \$25. Dan Schmidt, 10421 Lorain Ave., Cleveland, OH. (216) 252-3112 days, (216) 225-7568 evenings.

Best offer buys 1965 "K" model fastback body shell. Was in fire. Good frame quarters and floors. Posi-trac rear end. No front suspension or sheet metal. Jim Fears, 3205 W. Clarendon, Dallas, TX 75211.

Tach and clock repair. 65/73 consoles, grills, dash pads, visors, pony lights, handles, wheels, glove box doors, 67 NOS steering wheel saddle, 66 NOS PS pump kit, 6 cyl. Joe Russell. (914) 628-4866 after 6 pm.

Back by popular demand Boss 302 Shaker Hood Scoops mounting brackets (fits all shaker hood scoops) with attaching parts. \$11.95 shipping included. Bob Tessarolo, 227 James #6, Bensonville, IL 60106. (312) 860-7077.



Manufacturer and Distributor of:
O.E.M. STANDARDS
AUTOMOTIVE PARTS
AND ACCESSORIES

★ MUSTANG ★★★★★★★★ MUSTANG ★



- 69-70 FASTBACK REAR WINDOW WEATHERSTRIP..\$54.95
- 67-70 BACK-UP LAMP HOUSING GASKET IN ORIGINAL GREY COLOR--A MUST FOR SHOW CARS..\$2.25

★ MUSTANG ★★★★★★★★ MUSTANG ★

MORE MUSTANG QUALITY PARTS

64-68 Shift Boot.....	\$ 8.50
64-66 Fan Shroud Bracket.....	2.00
64-66 Alr Cond Firewall Gromet.....	4.00
64-66 Arm Rest Base.....	10.50
64-66 Lighter Knob & Element.....	9.95
64-66 Pony Trunk Key Blank.....	1.95
64-66 Pony Ignition Key Blank.....	1.95
65-66 Back-up Lamp Housing Gasket.....	2.00
64-66 Tail Lamp Bezel Gasket (pair).....	2.25
64-66 Tail Lamp Lens Gasket (pair).....	3.25
64-66 Door Seals (pair).....	9.45
64-66 Quarter Post Seals (pair).....	9.45
67-68 Door Seals (pair).....	9.45
67-68 Quarter Post Seals (pair).....	9.45
64-66 Outside Mirror Gasket.....	2.95
67-69 Outside Mirror Gasket.....	4.00
64-69 Heater Plenum Chamber.....	39.95
65-66 Fender Script 'MUSTANG' 4 7/8".....	7.50
65 Gas Cap.....	35.95
66 Gas Cap.....	34.95
66 GT Gas Cap.....	34.95
67 Gas Cap.....	39.95
69-70 Fastback Quarter Post Seals (pair).....	10.95
64-66 A/C Filter-Drier.....	24.95
64-66 Hood Cowl Seal w/clips.....	7.95
67-68 Hood Cowl Seal w/clips.....	7.95
67-68 Rear Bumper Guard Pad.....	4.95

Prices include postage (COD's Add \$3.00 per Pkg.)
Mastercard and Visa welcome.



33 WOOLFOLK AVENUE
MIDLAND CITY, ALABAMA 36350
TELEPHONE (205) 983-1212

TOLL FREE ORDER LINE 1-800-421-6880

**PUT A LID ON COWL
VENT LEAKS NOW!**



WITH "COWL-CAP"
BY **PonyCraft**

NO MORE WORRIES!

- Postpone costly cowl repairs
- Prevent future problems before they start by eliminating rain water build-up in the cowl, inner fender and floor pan areas.

FEATURES!

- Constructed in unbreakable lexan
- Water-tight rubber seal
- Spring loaded quick-locks hold "COWL-CAP" down tight without damaging grill work - even when vehicle is in motion
- Stores in trunk - installs in seconds

Now Available For 64-68 Mustangs
(Specify Year) - Other Models Available Soon

The Ultimate In
PONY PROTECTION for \$24.95

Please Add 10% For Shipping & Handling
Send Check or Money Order Payable To

PonyCraft

P.O. Box 1522, Brockton, MA 02403
Call 617-293-2196

PARTS WANTED

FDA-14303 ASX Ground Cable, from starter to firewall for 1965 Mustang 6 cyl. "200" engine. NOS or very good condition only. George Greinke, 3721 Harrison Avenue, Brookfield, IL 60513.

Deluxe red seat belts for 1967 Mustang. Buckles are covered with red vinyl and chrome release button. Must be excellent and complete set. (704) 867-6153 NC.

Rubber dust cover for generator and original burtex trunk mat both for 6 cyl. 1964½ coupe. Best possible condition required. Richard Stginkopf, 10 N. Voorhees Dr., Basking Ridge, NJ 07920. (201) 221-1895 evenings.

Any working parts related to a convenience control panel for a 1967 or 1968 Mustang. J. D. Zaleski, 510 Oak St., Ext., Bethesda, OH 43719. (614) 484-4352.

MISCELLANEOUS FOR SALE

Classic Mustang prints, beautiful full color 16" x 20" 1965-73 frameable prints. Also metal and plastic model kits. Send for list. Bill Koivu, P.O. Box 539, Pine Lake, GA 30072.

Mustang "A Legend Turns Twenty" poster. Official Ford Motor Co. anniversary poster featuring "29" 1964½-1984 Mustangs. A true collector's item — order yours today, don't be disappointed. Shipped postpaid, \$6.95 or two for \$10.95. Bill Koivu, Dpt. P., P.O. Box 539, Pine Lake, GA 30072-0539.

CENTRAL MUSTANG SUPPLY

Rear Wheel Flair \$54.00 M101A 65-66

Finally, you can repair your quarter panel to the door jamb and over the wheel flair with one panel! Plenty of flange for easy installation. Be sure to specify side.

Specializing in 1965-73 Mustangs
New and Used Parts
**GLENMONT ROAD [518] 462-4780
GLENMONT, N.Y. 12077**

RESTORATIONS • REPAIRS •
DETAILING • MODIFICATION

**64½ - 73 MUSTANGS
SHELBSYS**

CARS & PARTS
BOUGHT • SOLD • TRADED

LEE MATHIAS
3853 MOON STATION RD
KENNESAW, GA 30144
404/427-0382

MUSTANG FARM

Hours
Mon.-Fri. 9-6
Sat. 9-4

CENTRAL MUSTANG SUPPLY

Complete Battery Tray Special
Kit Includes: NOS Battery Tray, NOS Hold-Down; NOS Bolts

	LIST	YOUR COST	Quantities Limited
65/66	\$15.35	\$13.05	Please Specify Year When Ordering
67/69	27.53	23.40	NO COD'S—Add \$2.00 Shipping
70	27.52	23.40	
71/73	15.40	13.10	

Specializing in 1965-73 Mustangs
New and Used Parts
**GLENMONT ROAD [518] 462-4780
GLENMONT, N.Y. 12077**

• PERFORMANCE PARTS / BUY, SELL and TRADE
• MUSTANGS PARTS

Snakeman Enterprises

Harvard Still
Contact "Snakeman"

615/479-7314 • RT 9 BOX 588 • CLEVELAND, TENNESSEE 37311

Now, it's available to you!

DON'T SPOIL IT, SSSNAKE-OYL IT!

SSSNAKE-OYL

PENETRANT

Finally, SSSNAKE-OYL products are available to restorers, hobbyists and handymen everywhere.

- The secret of industrial users for over 40 years. Now revealed!
- 35,000 industrial users say this is the best.
- Salvages previously discarded parts.
- Loosens frozen metal parts.
- Quickly penetrates rust and corrosion.
- Money back guarantee.

For FREE descriptive literature, or to order, write:
SSSNAKE-OYL PRODUCTS
15775 N. Hillcrest
Suite 508-452
Dallas, TX 75248
or call
214/233-3047

Available in 10 oz. aerosol
Send Only 4.99 plus 11.00 shipping and handling. Texas residents add 6% sales tax.

ASK ABOUT OUR SPECIAL DEALER PROGRAM

SHIELD YOUR MUSTANG

Now Available 1964½ - 1968

\$10.95* set

Please Specify Body Style and Deluxe or Standard Interior

Pre-cut, waterproofed shields made to fit 1964½-68 Mustangs will create a barrier against water, noise and outside temperatures. Exactly the same as the original, only better! Coupe and convertible sets include rear quarter shields.

SSSNAKE-OYL

SSNAKE-OYL PRODUCTS
15775 N. HILLCREST • SUITE 508-452
DALLAS, TEXAS 75248 • 214/233-3047
*Texas Residence Add 5% Sales Tax
Shipping Charge - \$2.00
Dealers Welcome

A NEW PRODUCT

\$4.95* Pair

Woodgrain door handle inserts for 1965-66 Mustangs with Interior Decor (Pony) Option. Precision die cut from pressure sensitive vinyl. Perfect fit that is guaranteed to stay on and looks like new!

SSSNAKE-OYL

SSNAKE-OYL PRODUCTS
15775 N. HILLCREST • SUITE 508-452
DALLAS, TEXAS 75248 • 214/233-3047
Dealers Welcome
*Texas Residence Add 5% Sales Tax

APOGEE ENTERPRISES cordially invites you to something special — a very important conference with our nationally famous expert of over 50 years experience in road illumination, and consultant to some famous light companies. A rare opportunity awaits you to achieve greater safety and pleasure in night driving. We'll introduce you to a whole new world of lighting technology that is way ahead of anything you have ever known!! Much better road lighting than the new sealed beam halogen headlamps is mandatory (as our customers have discovered) to reduce the great toll of night accidents which are about 3 times more than daytime. Apogee is on a definite crusade to reduce this hazard which too often snuffs out lives, and we can do this if you "act" by cooperating. *How?* Through education and action — by ordering our famous "Whole Light Catalog" & Questionnaire — read it carefully and jot down questions — fill in the questionnaire and send it to us so that our expert can personally answer you and advise you in selecting the best combination of scientific beam patterns that offer the best lighting for your individual requirements. Ordinarily this could cost you \$25 to \$50 for this valuable help, but we are offering this "free" to you and no obligation to buy any lamps. We feel that knowledge comes before action and if you "get it" you'll surely act wisely. But without the "tools" the catalog and questionnaire would be much too difficult and time consuming for you and our advisor. The catalog contains the greatest variety of the world's finest headlamps, fog and driving lamps, switches, relays and valuable information. To make it all complete — we stock the nation's largest variety of top grade lamps at big discounts. Moreover we offer another discount to car club members and to repeat customers who boost us, and dealers are welcome. Get started on a new adventure. Send \$5.00 for the "Whole Light Catalog" and experience a unique "enlightenment" — so *Do it now.*"

We guarantee satisfaction way beyond factory warranties and all our customers become our friends — coming back for future needs.

APOGEE ENTERPRISES
 P.O. Box 266
 Sheboygan, WI 53081-0266
 Dial (414) 458-2766

Your "One Source" for Mustang Parts!

- ★ SPECIALS ON KITS
- ★ MORE NEW REPROS
- ★ 10% OFF DEALS
- ★ FREE SHIPPING
ON UPS ORDERS OVER \$200



THE PADDOCK® SINCE 1965! THE LEADER IN MAIL ORDER PARTS & ACCESSORIES FOR AMERICAN PONY CARS!

Our clear & comprehensive catalogs help you keep up to date on the latest parts & repros available. Your parts are shipped promptly from 2 conveniently located stores.

- SHEET METAL • UPHOLSTERY • CARPET • SOFT TRIM
- HIGHEST QUALITY REPROS • LITERATURE • DECALS
- GENUINE FORD PARTS • WEATHERSTRIPPING • FASTENERS
- ACCESSORIES • INTERIOR PAINT • SUSPENSION PARTS
- PERFORMANCE ITEMS • FIBERGLASS
- RESTORATION & DETAILING SUPPLIES

THE MUSTANG CATALOG THAT KEEPS ON COMING!

Send your name and address, with **ONE DOLLAR** and you'll receive our new sale catalog, plus being included in future mailings **FREE!**

IF YOU CAN'T WAIT - call 800-428-4319 and we'll send yours out right away first class and charge your Visa or MasterCard \$2.70. That also puts you on our permanent mailing list. **ACT NOW!**



INDY STORE

CAL STORE

the paddock inc.

221 W. Main St. Box 30 Dept. MT. Knightstown, IN 46148
 800-428-4319. Info Line 317-345-2131

paddock west

446 Tennessee St. Dept. MT. Redlands, CA 92373
 800-854-8532. Info Line 714-798-4166

THE BOTTOM LINE! It all boils down to having what you want in stock, giving good service on your order, quick shipment, and a good return policy. We strive to be dependable with your money and needs for your car. Ask any one of our customers and then call us, we'll work hard at pleasing you.

MCA ACCESSORIES

Mustang Sportswear

Arrow sports shirts



1st line quality Arrow sports shirts with pockets and MCA logo embroidered. Available in tan, red, navy blue and white.

Adult Sizes: S, M, L, XL \$19.95 ea.

MCA Hats (Mens at Ladies) 5.50

MCA Jackets, unlined, bright yellow. 22.00

MCA Jackets, lined, bright yellow. 29.00

Adult Sizes: S, M, L, XL
(includes MCA 8" patch)

Mustang Club of America Cloth 3" Emblem \$2.50

Mustang Club of America Cloth 8" Emblem 6.00

Mustang Club of America Windshield Decal 1.00

Mustang Club of America Front License Plate 3.00

Back issues of the *Mustang Times* 2.00

Mens MCA Watch 19.95

Ladies MCA Watch 19.95

Please add 10% for shipping

Add 10% for shipping

Send checks to:
MCA Accessories
% Bill Koivu
1462 Wendover Ct.
Stone Mtn., GA 30083

MCA Front License Plate

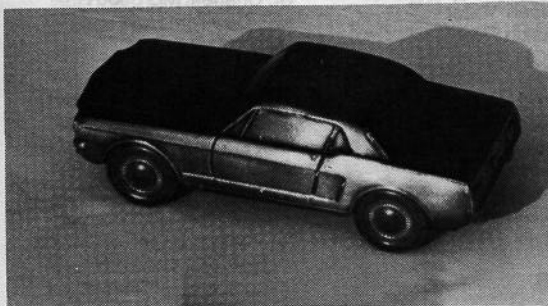

65 Mustang
Banks
(Metal construction)
\$12.95 each



Mens MCA Watch
Ladies MCA Watch

MCA Hats

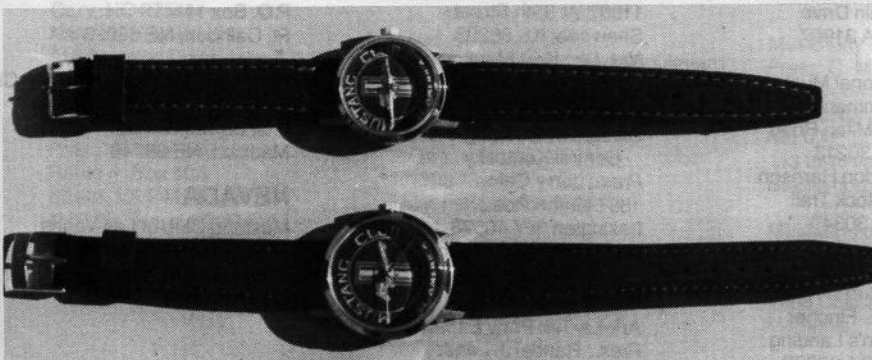

REGIONAL GROUPS

ATTENTION ALL REGIONAL GROUPS

The regional group listing will be updated once every three months. All new groups will be listed on the President's page until the primary listing is updated.

ALABAMA

Birmingham Regional Group
Pres.: Bob Wood
5735 Annadale Lane
Birmingham, AL 35210
Nat. Dir.: John Aldridge
541 Pine Oak Drive
Birmingham, AL 35214

Heart of Dixie
Mustang Club
Pres.: Jerry B. Lowery
4691 Summit Drive
Milbrook, AL 36054
Nat. Dir.: Robert E. Messick
1904 Gatsby Drive
Montgomery, AL 36106

Model City Mustang Club
Pres.: David Spellman
5804 Medders Street
Anniston, AL 36201
Nat. Dir.: Eddie Ford
5616 Arrow Avenue
Anniston, AL 36206

Rocket City Mustang Club
Pres.: Bill Newton
606 Marion Drive
Madison, AL 35758

Shoals Mustang Club
Pres.: Johnny Bishop
P.O. Box 307
Cherokee, AL 35616

Wiregrass Mustang Club
Pres.: Carl Bruner
1306 Galaxie Drive
Dothan, AL 36301

ARIZONA

Copper State Mustang Club
Pres.: John D'Ambrosio
2049 W. McRae Way
Phoenix, AZ 85027

CALIFORNIA

Highway Horsemen
Southern California
Pres.: Steve Bilderein
P.O. Box 877
Ontario, CA 91761

Golden Hills Mustang Club
Pres.: Scott McNair
420 Sarah Way
Suisun City, CA 94585
Nat. Dir.: Scott McNair

Northern Valley Mustang Club
Pres.: Virgil Willard
1050 Jay Street
Marysville, CA 95901
Nat. Dir.: Dennis Stanford

DELAWARE

The First State Mustangs
Pres.: Doug Martin
6232 Telegraph Road
Elkton, MD 21921
Nat. Dir.: Jill Smethers
16 Duquesne Court
New Castle, DE 19720

FLORIDA

The Gold Coast Mustang Club
Pres.: Bob Acosta
5290 SW 8th Street
Miami, FL 33134

Ft. Lauderdale Mustang Club
Pres.: Larry Hurst
725 Azalea Court
Plantation, FL 33317

Treasure Coast Mustang Club
Pres.: Greg Michaelian
762 S.W. Falcon Street
Palm City, FL 33490
Nat. Dir.: Mike Owen
3800 S.W. St. Lucie Shores Drive
Palm City, FL 33490

Gulf Coast Regional Group
Pres.: Bob McNeal
8701 Fowler Avenue
Pensacola, FL 32514
Nat. Dir.: Garry Hendrix
Rt. 2, Box 182
Cantonment, FL 32533

Hernando County Mustang Assn.
Pres.: Tony Lagone
25272 W. Plum Street
Brooksville, FL 33512

Central Florida Regional
Mustang Club
Co-Pres.: R. W. Simmons
Henry Howard, Jr.
Nat. Dir.: Ken Daniel
P.O. Box 2426
Orlando, FL 32802

GEORGIA

Bi-City Regional Group
Pres.: Alan C. Ramsay
3512 Algonquin Drive
Columbus, GA 31907

Georgia Regional Mustang Club
Pres.: Gail Ammans
Route 1, 425 Milan Road
Fairburn, GA 30213
Nat. Dir.: Gordon Harrison
2915 Green Rock Trail
Doraville, GA 30340

West Georgia Regional
Mustang Club
Pres.: Larry E. Fincher
Rt. 2, Grayson's Landing
Hogansville, GA 30230

ILLINOIS

Central Illinois Mustangers
Pres.: Henry Abel
RR #1
Illipolis, IL 62539
Nat. Dir.: Bob Dobrinick
98 Isabella Drive
Decatur, IL 62521

Coal Country Mustang Club
Pres.: Felix Tate
2150 Grand Avenue
Eldorado, IL 62930
Nat. Dir.: Nelson Fowler
RR #3, Box 165
Eldorado, IL 62930

Mid-America Regional Group
Pres.: Monty Shehorn
120 Smith Avenue
Flora, IL 62839
Nat. Dir.: Same as above

Southern Illinois Mustang Assoc.
Pres.: Harry Kulp
214 Chelsea Lane
Brighton, IL 62012
Nat. Dir.: O. Schwallenstecker
Box 494
Bunker Hill, IL 62014

INDIANA

Hoosier Mustang Club
Pres.: Don Lawless
P.O. Box 2065
Columbus, IN 47202-2065
Nat. Dir.: Same as above

Old Fort Mustangers
Pres.: Chuck Edwards
108 W. Arthur St.
Hicksville, OH 43526
Nat. Dir.: Noah Yoder
Rt. 1, Buckskin Rd.
Hicksville, OH 43526

Pony Express River City Mustangs
Pres.: Randy Adams
1003 Corregidor
Evansville, IN 47714
Nat. Dir.: Scott Seitz
601 Locust Street
Mt. Vernon, IN 47620

KANSAS

Kansas City Mustang Club
Pres.: Ernie Pyle
11807 W. 55th Street
Shawnee, KS 66203
Nat. Dir.: Kert Maul

KENTUCKY

Bluegrass Mustang Club,
Central Kentucky
Pres.: Jerry Caton
1887 Linton Road
Lexington, KY 40578
Nat. Dir.: Same as above

LOUISIANA

Ark-La-Tex Pony Express
Pres.: Randal J. Landry
627 Gladstone Boulevard
Shreveport, LA 71104

Baton Rouge Mustangers
Pres.: Billy DeWitt
Nat. Dir.: LaNita Braud
Rt. 2, Box 232F
Geismar, LA 70734

MARYLAND

Mustang Club of Maryland
Pres.: Gene Schwandtner
P.O. Box 23
Bel Air, MD 21014
Nat. Dir.: Same as above

MICHIGAN

Michiana Mustangs
Pres.: Bob Kasprzak
19629 Old Ridge Road
South Bend, IN 46614
Nat. Dir.: Same as above

Mustang Owners Club of
Southeastern Michigan
Pres.: Mark Bednarek
P.O. Box 39088
Redford, MI 48239
Nat. Dir.: Don Gillespie
33070 Rosslyn
Garden City, MI 48135

MISSISSIPPI

Mississippi Coast Mustang Club
Pres.: Jack Wilbanks
127 Vista Dr.
Pass Christian, MS 39571
Nat. Dir.: Keith Dern
421 Azaela Court
Biloxi, MS 39531

MISSOURI

Mid-Missouri Mustangs
Pres.: Fred Nothstine
2701 Essex Street
St. Charles, MO 63301
Nat. Dir.: Tom Hoyt

MONTANA

Treasure State Mustang Club
Nat. Dir.: Kevin McAtee
Box #3, 810 N. 7th
Bozeman, MT 59715

NEBRASKA

Mustang Car Club of Omaha
Pres.: Mark Meswarb
2606 S. 152nd Circle
Omaha, NE 68144
Nat. Dir.: Ron Miller
P.O. Box 141
Ft. Calhoun, NE 68023

Northeast Nebraska Mustang Club
Pres.: Rich Borer
P.O. Box 214
Madison, NE 68748

NEVADA

Mustang Club of Las Vegas
Pres.: Phil Smithey
2485 Marlene Way
Henderson, NV 89015

NEW JERSEY

Central Jersey Mustang Club
Nat. Dir.: Robert Stuart
34 Sturwood Drive
Belle Mead, NJ 08502

North Jersey Mustang Club, Inc.
Pres.: Ben Ballone
Nat. Dir.: John K. Griffith, Jr.
P.O. Box 212
Northvale, NJ 07647

South Jersey Mustangs
Pres.: Rich Riley
681 North Mill Road
Vineland, NJ 08360

NEW MEXICO

Rio Grande Mustang Club
Pres.: Gary Spear
Nat. Dir.: Tom Anderson
1521 Eastridge Drive, N.E.
Albuquerque, NM 87112

NEW YORK

Mustang of Buffalo
Pres.: Ray Kelm
P.O. Box 272
N. Tonawanda, NY 14120
Nat. Dir.: Bill Lewis

Adirondack Shelby-Mustang
Regional Club, Inc.
Pres.: Steven P. Lyke
P.O. Box 107
Burnt Hills, NY 12027
Nat. Dir.: Robert Contompasis
2210 Central Avenue
Schenectady, NY 12304

Twin Tier Regional Group
Pres.: Howard Steiner
53 William Street, Box 417
Spencer, NY 14883

NORTH CAROLINA

Carolina Regional Mustang Club
Pres.: Jim Sachak
2517 O'Hara Drive
Charlotte, NC 28210
Nat. Dir.: Perry Rivers
Route 1, Box 421 L17
Harrisburg, NC 28075

Eastern North Carolina
Regional Group
Pres.: Randy Daniels
801 Madison Avenue
Cary, NC 27511
Nat. Dir.: Ray Whitley
813 Pamlico Drive
Cary, NC 27511

First Piedmont Regional Group
Pres.: Jesse Williams
Route 4, Box 50A
Stuart, VA 24171
Nat. Dir.: Harold D. Goad
Rt. 2, Glenwood Terrace
Stuart, VA 24171

The Gate City Triad Mustang Club
Pres.: Bobby Smith
401 Cooke Drive
Elon College, NC 27244
Nat. Dir.: Bob Summers
P.O. Box 378
216 Circle Drive
Gibsonville, NC 27249

Sandhills Regional Group
Pres.: Howard Craig
422 N. Wright Street
Raeford, NC 28376
Nat. Dir.: Billy Craig
411 N. Wright Street
Raeford, NC 28376

OHIO

Hall of Fame Mustangers
Nat. Dir.: John Hembree
2404 Clarendon Avenue, NW
Canton, OH 44708

Northeastern Ohio Regional Group
Pres.: Joe Blazek
5713 Allyn Road
Hiram, OH 44234
Nat. Dir.: Jim Watson
2600 Chestnut Boulevard
Cuyahoga Falls, OH 44223

Northwest Ohio Regional Group
Pres.: Hugh B. Black
P.O. Box 86
Bucyrus, OH 44820
Nat. Dir.: Larry Graser
786 Sandalwood Road, W.
Perrysburg, OH 43551

Tri State Mustang
Pres.: Terrence Rotert
3415 Oakmeadow Lane
Cincinnati, OH 45239
Nat. Dir.: Bill Sullivan
P.O. Box 41538
Cincinnati, OH 45241

PENNSYLVANIA

First Pennsylvania Mustang Club
Pres.: Cliff Zimmerman
RD 2, Box 406
Breinigsville, PA 18031
Nat. Dir.: Fred Glazier, Jr.
531 Wambold Road
Souderton, PA 18964

Centre Region Mustang Club
Pres.: Michael Beaver
1227 Mifflin Street
Huntingdon, PA 16652
Nat. Dir.: Tony Branda
1434 E. Pleasant Valley Boulevard
Altoona, PA 16602

Flood City Mustang Club
Pres.: Daryl G. Wagner
1305 Newbaker Drive
Johnstown, PA 15904
Nat. Dir.: Same as above

Northeast Pennsylvania
Regional Group
Acting Pres.: Arthur Dice
P.O. Box 51
Rock Glen, PA 18246
Nat. Dir.: Same as above

Three Rivers Regional Group
Pres.: Gene Hagerty
4196 Timerlane Drive
Allison Park, PA 15101
Nat. Dir.: Mike Flanders
RD 3, Circle Drive
Export, PA 15632

Valley Forge Mustang Club
Pres.: Warren Perkins, Sr.
243 Highland Avenue
Dowlingtown, PA 19335

SOUTH CAROLINA

Central South Carolina
Regional Group
Pres.: Craig Zion
P.O. Box 2614
Columbia, SC 29202
Nat. Dir.: Same as above

Foothills Regional Group
Pres.: Bernard Price
101 Eastover Drive
Nat. Dir.: Jim Payne
Rt. 1, P.O. Box 93
Piedmont, SC 29673

TENNESSEE

Golden Circle Mustang Club
Pres.: Harold E. Petty
78 Windy Hill Road
Jackson, TN 38301
Nat. Dir.: G. W. McNutt
536 Hopper Barker Road
Jackson, TN 38301

First Tennessee Regional Group
Pres.: Ernest Stout
3720 Hughes Drive
Kingsport, TN 37660
Nat. Dir.: Bill Henderson
Kenner Addition
Rogersville, TN 37857

Lakeway Mustang Club
Pres.: David Huffaker
Route 1
Kodak, TN 37764
Nat. Dir.: Charles Cross
City 5
Morristown, TN 37814

Music City Regional Group
Pres.: C. M. Gately
200 Green Harbor Road
Old Hickory, TN 37138
Nat. Dir.: Bob Overbey
113 In-A-Vale Drive
Brentwood, TN 37027

Mustangs of Memphis
Pres.: Ed Xiques
Nat. Dir.: Charles Young
4968 Chuck
Memphis, TN 38118

Scenic City Mustang Club
Pres.: Larry Eaton
16 Whispering Pines
Signal Mountain, TN 37377
Nat. Dir.: Same as above

Volunteer Regional Group
Pres.: Bob Murphy
7724 Windsong Road
Powell, TN 37849
Nat. Dir.: Doug Owen
1612 Foxboro Drive
Knoxville, TN 37921

TEXAS

North Texas Mustang Club
Nat. Dir.: Ron Clements
4313 Pleasant Run Rd. #155
Irving, TX 75062

Texas Panhandle Mustang Club
Pres.: Mike Lewis
Route 5, Box 744
Amarillo, TX 79118
Nat. Dir.: Terry Hawthorne
3820 Danbury
Amarillo, TX 79109

Texas Classic Mustangs
Pres.: Bob Fudge
109 Struss Lane
Columbus, TX 78934
Nat. Dir.: Joyce Fudge

VIRGINIA

Old Dominion Mustang Club
Pres.: Alvin J. Landes
Route 2
Bridgewater, VA 22812
Nat. Dir.: Robert Halterman
P.O. Box 193
Broadway, VA 22815

Mustelby Mustang Club
Pres.: Richard E. Graham
P.O. Box 12294
Roanoke, VA 24024
Nat. Dir.: Howard Lee Nichols
Route 3, Box 722
Moneta, VA 24121

Shenandoah Valley Mustang Club
Pres.: Leonard Foltz
1223 Crest Circle
Winchester, VA 22601

WISCONSIN

Wisconsin Early Mustangers
Pres.: Dick Doria
2511 W. Carrington Avenue
Oak Creek, WI 53154
Nat. Dir.: Dick Cole

CANADA

Alberta Mustangs
Pres.: Wayne Rudd



RUSH TO

FROM
NATIONAL HEADQUARTERS
THE MUSTANG CLUB OF AMERICA, INC.
P.O. BOX 447
LITHONIA, GEORGIA 30058