

Mustang Times

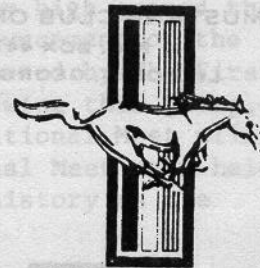

The Official Newsletter of

The Mustang Club of America

NOVEMBER 1977



 NEWS FLASH.....
 MUSTANG CLUB OF AMERICA
 EASTERN NATIONAL MEET
 KINGSPORT, TENNESSEE
 MAY 26-28, 1978
 HOSTED BY
 FIRST TENNESSEE
 REGIONAL GROUP Inc. ★

CAR OF THE MONTH
1966 MUSTANG G.T. CONVERTIBLE

OWNED BY
PASQUALE (PAT) VASSALLO

WHEATON, ILLINOIS

Story page 4

NATIONAL HEADQUARTERS
THE MUSTANG CLUB OF AMERICA, INC.
 P. O. BOX 447
 LITHONIA, GEORGIA 30058

OFFICERS

President . . . GARY GODDARD LITHONIA, GEORGIA
Vice-Pres . . . KEN YEAGER DECATUR, GEORGIA
Secretary . . . JIM OSBORN DECATUR, GEORGIA
Treasurer . . . GEORGE WHITE SMYRNA, GEORGIA

BOARD OF DIRECTORS

LEE GREENFIELD GRAYSON, GEORGIA 10-1-78
 GEORGE WHITE SMYRNA, GEORGIA 10-1-78
 JACK HUFF GRAYSON, GEORGIA 10-1-79
 BILL HATFIELD FRANKLIN, NORTH CAROLINA 10-1-79
 DENNY ARRINGTON LAWERENCEVILLE, GEORGIA 10-1-79
 JACK YEAGER DECATUR, GEORGIA 10-1-79
 MAX EPPS CHURCH HILL, TENNESSEE 10-1-79
 BRENT DANNEMAN ATLANTA, GEORGIA 10-1-79
 LARRY DOBBS LAKELAND, FLORIDA 10-1-79
 CHARLIE JONES JR. NASHVILLE, GEORGIA 10-1-79

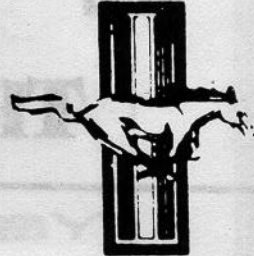
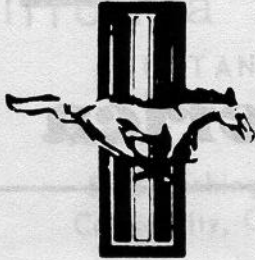

NEWS STAFF

News Editor . . . JIM OSBORN DECATUR, GEORGIA

MEMBERSHIP * The membership fee is \$15.00 annually and will be due upon the expiration date of your membership.

PAYMENT OF DUES * The Mustang Club of America cannot be responsible for cash sent through the mail. We request any transaction be made by check or money order and made payable to The Mustang Club of America.

CHANGE OF ADDRESS * Please notify the club immediately of any change in your address.

OPERATING BUDGET * The Mustang Club of America does not pay its officers salaries or hourly wage earnings. All money received goes directly into operating the club.

MUSTANG TIMES ADVERTISING RATES
ONE ISSUE

1/4 Page - - - - - \$ 8.00
 1/2 Page - - - - - 15.00
 3/4 Page - - - - - 22.50
 Full Page - - - - - 30.00

FULL YEAR

1/4 Page - - - - - \$50.00
 1/2 Page - - - - - 100.00
 3/4 Page - - - - - 150.00
 Full Page - - - - - 200.00

Please send all Mustang Time correspondence to:

Jim Osborn
 3229 Pheasant Drive
 Decatur, Georgia 30034

FROM OUR PRESIDENT

I would like to urge everyone to start making plans to attend the All Ford Parts Swap Meet at Nashville, Georgia on January 13th & 14th, 1978 being hosted by Ford, Inc. The Club will have a display at this show and will be signing up new members...so stop by and see us. For more information on this meet, write me at the National Headquarters.

Our next National Meet will be the Eastern National May 26, 27 & 28, 1978 at Kingsport, Tennessee hosted by The First Tennessee Regional Group. I urge everyone to start making their plans to attend this meet. This date is a long, holiday weekend with the following Monday's being the holiday. The First Tennessee Regional Group has been working hard to make this the best meet yet.

There will be more concerning the Eastern National Meet in the next issue of the Mustang Times.

Gary Goddard, President

STONE MOUNTAIN PICTURES

Anyone wishing to purchase a picture of their car taken at the Grand National Meet at Stone Mountain, Georgia, please contact:

David Barfield
 162 St. Marys Court
 Conyers, Georgia 30207

(404) 922-6295

TECHNICAL CORNER

If you have a problem or question about your Mustang, the following fellows will assist you:

Technical Advisor: John Vermeersch
 J & E Racing Engines
 40631 Irvin
 Mt. Clemens, Michigan 48045
 (313) 468-FORD

Features & Accessory Advisor:
 Alec J. Karacsony
 75 Venta Drive
 Northford, Connecticut 06472

Letters only

Maintenance Advisor: Bobby Pace
 168 Prince Anthony Drive
 Lawrenceville, Georgia 30245
 (404) 963-9909

Restoration Advisor: Fred R. Glazier, Jr.
 R. D. No. 1
 Souderton, Pa. 18964
 (215) 723-9674

1967 MUSTANG PRODUCTION FIGURES

65A 2d Hardtop	325,853
65B 2d Hardtop Lux.	22,228
65C 2d Hardtop Bench	8,190
63A 2d Fastback	53,651
63B 2d Fastback Lux.	17,391
76A Convertible	38,751
76B Convertible Lux.	4,848
76C Convertible Bench	1,209



FROM THE EDITOR

Excitement is running extremely high around the National Office since the announcement of the Eastern National Meet being hosted by The First Tennessee Regional Group. Knowing this group, and their hospitality, this National Meet will be the biggest and best National Meet ever held and will probably go down in history as the Eighth Wonder of the World.

Now is the time to order those Mustang Club accessories for Christmas presents and remember it is always a good idea to give a membership as a gift. **DO IT NOW - AVOID THE CHRISTMAS MAIL RUSH!**

Jim Osborn, Editor

WIN A MUSTANG CLUB OF AMERICA T-SHIRT!

We are starting a monthly contest and will award a free Mustang Club of America T-Shirt to the first two members who correctly answer our Question of the Month. These answers are to be submitted on a postcard (noting on this card also your shirt size) and mailed to The National Headquarters, P. O. Box 447, Lithonia, Georgia 30058.

November Question of the Month:

"What was the advertised ply rating of a 1966 Mustang convertible top?"

Deadline for answers is Saturday, November 26.

NOTE: The following decals are available to Club Members from the Mustang Club of America at discount prices. Order yours from the home office today. 289-2V, 289-4V, 289 Hi-Po, Innerfender, Glove Box, and Jacking Instruction Your choice: \$1.50 each.

CHILTON'S 1965-73 MUSTANG TUNE-UP and REPAIR MANUAL 270 PAGES

REGULAR PRICE \$6.95 MEMBERS COST \$5.50

THE MUSTANG CLUB OF AMERICA OFFICIAL ACCESSORIES

Cloth Jacket Emblems - 3"	\$2.00
Cloth Jacket Emblems - 8"	5.00
T-Shirts (Adults)	4.00
(S-M-L-XL)	
(Children)	3.50
(S-M-L)	
Windshield Decal	1.00
1976 National Meet Dash	
Plaque	1.00
1977 National Meet Dash	
Plaque	1.00

Order from NATIONAL HEADQUARTERS

CAR OF THE MONTH

1966 MUSTANG GT CONVERTIBLE

OWNED BY: PASQUALE (PAT) VASSALLO

Fourteen months ago I had an occasion to walk through the Ford Museum in Dearborn, Michigan. On display was a 1965 Mustang Convertible. The car brought back fond memories of the two new Mustangs that I had purchased in '65 and '66. It was there that I decided to possess the "Collector Car" of the sixties. The Ford Museum experience kicked off my personal search for a '65-'66 Mustang Convertible.

I work as a Regional Manager for a restaurant chain. My job affords me the opportunity to travel within the United States. In each city I visited, I purchased local newspapers and gleaned out Mustang ads. I looked at over 100 cars. Only a few interested me and none of them had all the equipment I wanted.

After driving a lot of used Mustangs, I knew that a "GT" version was what I wanted. The suspension and steering was far superior to the regular production models.

My search came to an end when I saw an ad in Hemmings Motor News last spring-

"1966 Mustang GT convertible completely restored. Inc. new paint, carpets, N.O.S. chrome, 5 new tires, opt. Equipment includes pony int. rally-pac., wire wheel hubcaps. 289 CID 225 HP 4 Speed equa-lk rear. Tinted glass. Perfect cond. in and out, Glaziers Antique Auto"

There it was, I called and Fred Glazier was at a Mustang Flea Market trying to sell the car. Luckily he was not successful.

I bought the car a few weeks later and drove it back to Chicago, over 800 miles. I averaged 17+ miles per gallon and used about ½ a quart of oil. Not bad for a eleven year old Mustang.

Since I purchased the car I have invested an additional \$600 in Styled Steel Wheels, door edge guards, pony mats, weatherstrips, door handles, right side mirror, antenna, threshold plates, miscellaneous chrome and soft trim.

Fred did a fine job of restoring the car and I was happy to add the finishing details that make the car show and look new.

Owning, driving, and working on the car has provided many enjoyable hours. My association in the Mustang Club of America has given me the chance to meet and correspond with many fine people connected with Ford Mustangs.

Future outlook? Hunt for a few still elusive parts, enjoy the car, and maybe look for a '66 GT pony, 2+2 who Knows!

Regards,

Pasquale (Pat) Vassallo



Editor's Note: I would like to thank Pat Vassallo for giving us the privilege of featuring his fine Mustang as this month's car of the month.

1971 MUSTANG

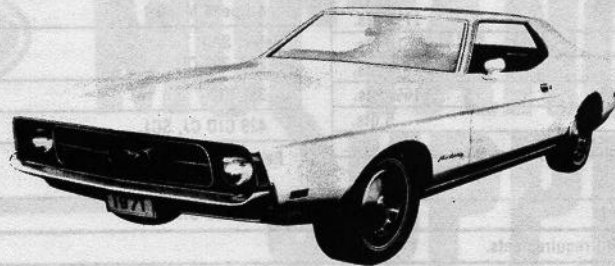

MODELS

- HARDTOP • GRANDE • BOSS 351
- SPORTSROOF • CONVERTIBLE • MACH I FASTBACK

SERVICE LOCATIONS

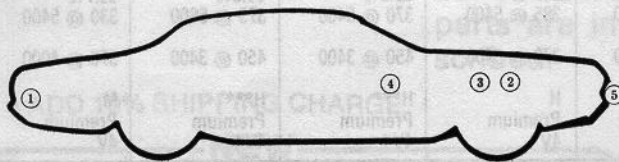

- ① GAS FILLER CAP—Rear—Center of Back Panel
- ② OIL FILLER CAP—6 cylinder: Rear of Rocker Arm Cover
8 cylinder: Front of Left Rocker Arm Cover (Except 351 4V HO CID, Right Rear)
- ③ PCV VALVE—Located in Rocker Covers: Front 250 CID
Left Front: 302, 351C 2V, 351C 4V CID; Right Rear: 302 Boss, 429 4V CJ, 429 4V SCJ CID & 351 4V HO CID
- ④ FUSE PANEL—Located on Plate Attached to Lower Right Hand Flange Brake Pedal Support
- ⑤ HOOD LATCH—Upper Center of Grille
To Open: Pull Lever to Left and Hold—Raise Hood

LIGHTS (12 VOLTS)

Lamp Description	Candle Power or Wattage	Trade Number
Headlights Hi-Lo Beam	40 & 50W	6012
Front Park/Turn Signal	3-32 c.p.	1157
Side Marker/Front, Rear	2 c.p.	194A
Rear Tail/Stop/Turn Signal	3-32 c.p.	1157
Back-up Lamp	32 c.p.	1156
License Plate	4 c.p.	97
Dome Lamp	12 c.p.	105
Emergency Flashers (included in Front/Rear Turn Signals)		
Instrument Panel		
Hi-Beam Indicator	2 c.p.	194
Turn Signal Indicator	2 c.p.	194
Warning Lights	2 c.p.	194
Fuel and Speedometer	2 c.p.	194
Glove Compartment	2 c.p.	1895
Deluxe Seat Belt	2 c.p.	1891
Heater (or Optional A/C) Controls	2 c.p.	1895
Clock	2 c.p.	194
Courtesy Lamp	6 c.p.	631
Accessory Equipment		
Fog Lamps—Clear	35W	4415
Fog Lamp Switch	1 c.p.	53X
Spotlight	30W	4405
Radio Pilot Light/AM/AM-FM/AM Stereo	1.9 c.p.	1893
Luggage Compartment	6 c.p.	631
Engine Compartment Lamp	6 c.p.	631
Parking Brake Warning	2 c.p.	256
Map Lamp	6 c.p.	212
Portable Trunk Lamp	15 c.p.	1003
AM/FM Radio Stereo Jewel	1.3 c.p.	1892
A—Amber Color Bulb		

CIRCUIT PROTECTION

Circuit	Location	Rating Amperes	Type Fuse or C.B.*
Headlights	Integral with Light Switch	12	C.B.
Tail Lights, Parking Lights, PRND21 Lamp, Front/Rear Side Markers, License Light	Integral with Light Switch	15	C.B.
Courtesy Lamps: Dome, Map, Instrument Panel, Door Lamps, "C" Pillar; Cigar Lighter Feed, Ignition Key Warning Buzzer, Automatic Seat Back Latch, Luggage & Glove Compartment	Fuse Panel	14	SFE
Engine Compartment Lamp	Cartridge in Feed Line	7.5	SFE
Emergency Flasher, Horns	Fuse Panel	20	AGC or SFE
Warning Lamps, Dual Brake, Distributor Vacuum Emission Control, Parking Brake, Seat Belt Warning	Fuse Panel	14	SFE
Back-up Lights, Windshield Washer and Radio, Turn Signals	Fuse Panel	15	SFE
Stop Lamps	Relay Panel above Glove Box	15	C.B.
Heater & Defroster	Fuse Panel	14	SFE
Air Conditioning (RPO)	Fuse Panel	30	SFE
Air Conditioning (Dealer Inst.)	Fuse Panel	30	SFE
Front Seat Back Latch Solenoid	Integral with Solenoid	—	C.B.
Windshield Wiper	Integral with Wiper Switch	7	C.B.
Power Window, Convertible Top, Heated Backlight	On Starter Relay	20	C.B.
Motors: Power Window, Convertible Top	Integral with Motor	—	C.B.
Instrument Panel Illumination, Heater Switch, Headlight Switch, W/S Wiper/Washer Switch, Ashtray, Radio and Gauge Illumination	Fuse Panel	4	AGA

*C.B. Circuit Breaker

MUSTANG

APPROXIMATE REFILL CAPACITIES (U.S. Measure)

Fuel Tank All Models	20 gal.	Transmission 3-Speed Manual	3½ pts.
Cooling System (Includes 1 qt. for heater) 250 CID	11¼ qts.	4-Speed Manual	4 pts.
302 CID and 302 BOSS	15 qts.	Select Shift 250, 302 CID	9 qts.*
351 CID (with A/C)	16¼ qts.	351 CID	11 qts.*
351 CID (without A/C)	16¼ qts.	429 CID CJ, SCJ	13 qts.*
302, 351 CID	5 qts.	Rear Axle 250, 302 CID	4 pts.
429 CID CJ, SCJ	19½ qts.	351, 429 CID	5 pts.
Engine Crankcase (Includes 1 qt. for filter) 250 CID	4½ qts.		
429 CID CJ/SCJ/Police (add 1 qt. for Oil Cooler)	7 qts.		

*Dry System: Dipstick used to determine exact fill requirements.

MUSTANG

ENGINE SPECIFICATIONS

Displacement & Cylinders	250-6	302-V8	351C-V8	351C-V8	429-V8*	429-V8**	351-4V HO V8
Type	In Line	90°V OHV	90°V OHV	90°V OHV	90°V OHV	90°V OHV	90°V OHV
Bore (Inches)	3.682	4.002	4.002	4.002	4.362	4.362	4.002
Bore and Stroke (Inches)	3.910	3.00	3.50	3.50	3.590	3.590	3.50
Compression Ratio	9.0:1	9.0:1	9.0:1	10.7:1	11.3:1	11.3:1	11.7:1
Brake Horsepower @ Specified rpm	145 @ 4000	210 @ 4600	240 @ 4600	285 @ 5400	370 @ 5400	375 @ 5600	330 @ 5400
Maximum Torque (lb.-ft.) @ Specified rpm	232 @ 1600	296 @ 2600	350 @ 2600	370 @ 3400	450 @ 3400	450 @ 3400	370 @ 4000
Valve Lifters H—Hydraulic M—Mechanical	H	H	H	H	H***	H***	M
Fuel	Regular	Regular	Regular	Premium	Premium	Premium	Premium
Carburetor	1V	2V	2V	4V	4V†	4V†	4V

*Cobra Jet (CJ) **Super Cobra Jet (SCJ). ***Mechanical with Drag-Pack Option.

†Manual Choke Holley with 780 cfm with Drag-Pack Option.

MUSTANG

ENGINE PERFORMANCE SPECIFICATIONS

Displacement & Carburetor	250-1V	302-2V	351C-2V	351C-4V	429-4V*	429-4V**	351-4V HO V8
Firing Order	1-5-3-6-2-4	1-5-4-2-6-3-7-8	1-3-7-2-6-5-4-8	1-3-7-2-6-5-4-8	1-5-4-2-6-3-7-8	1-5-4-2-6-3-7-8	1-3-7-2-6-5-4-8
Spark Plug Type (Autolite No.) and Size	BRF-82 (18mm)	BRF-42 (18mm)	ARF-42 (14mm)	ARF-42 (14mm)	ARF-32 (14mm)	ARF-32 (14mm)	—
Spark Plug Gap (Inches)	.032-.036	.032-.036	.032-.036	.032-.036	.032-.036	.032-.036	—
Distributor—Service Tip ①							
Point Gap (Inches)	.025	Service Tip ①	Service Tip ①	Service Tip ①	.020"	.020"	—
Point Dwell (Degrees)	37-42	Service Tip ①	Service Tip ①	Service Tip ①	24-29	24-29	—
Distributor Diaphragm Type	—	Service Tip ①	Service Tip ①	Service Tip ①	—	—	—
Idle rpm—Service Tip ①							
Manual Transmission (Without Throttle Solenoid)	—	—	—	—	700	700	—
(With Throttle Solenoid)***	750-500	800-500	700-500	800-500	—	—	—
Automatic Transmission (Without Throttle Solenoid)	550	575	—	600	650-500	650-500	—
(With Throttle Solenoid)***	600-500	600-500	650-500	—	—	—	—
Ignition Timing (BTDC)— Service Tip ② ③	6°	6°	6°	6°	10°	10°	—

*Cobra Jet (CJ). **Super Cobra Jet (SCJ). ***Higher Idle Speed with Solenoid Energized—Lower Idle Speed with Solenoid De-energized.

MUSTANG

SERVICE TIPS

① Adjust all idle speeds with headlights "ON", automatic transmission in "DRIVE" or manual transmission in "NEUTRAL" and if air conditioner equipped, place A/C controls in "OFF" position. Adjust HIGH IDLE SPEED with throttle solenoid operating by using the solenoid adjustment. Adjust the LOW IDLE SPEED using the carburetor idle speed screw with wire disconnected from throttle solenoid.

② The distributor DIAPHRAGM HOSE or HOSES must be disconnected and plugged.

③ If the individual requirements of the vehicle and/or use of sub-standard fuels dictate, the initial timing may have to be retarded from the "Normal" setting to eliminate detonation.

If retarding is necessary, it should be done progressively and not exceed 2 degrees B.T.D.C.

④ Dual Diaphragm distributors: *24-29 degrees dwell angle
.021 inches point gap

Single Diaphragm distributors: *26-31 degrees dwell angle
.017 inches point gap

*Use either specification when installing NEW POINTS. Use DWELL ANGLE specification when adjusting points having MORE than ONE HOUR usage.

⑤ Distributor Rotor Rotation: 6 cyl. Clockwise; 8 cyl. Counter-clockwise.



MUSTANG SUPPLY CO.

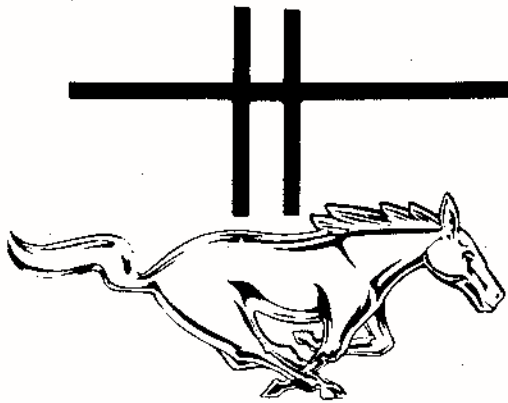

NOVEMBER SALE!

We are offering the below specials on limited quantities in our current stock, through November 30th, 1977. All new parts are in factory carton and used parts are as described.

• ADD 10% SHIPPING CHARGE

NEW

- 65/66 G.T. Wheel, Red center caps\$6
- 65/66 complete master cylinder assem\$18
- 67 Blue steering wheel.....\$20
- 65 13" wheel covers\$7
- 67 Pony & corral for grill\$15
- 65/66 chrome grill pony\$10
- 65 Gas Cap.....\$45
- 66 Gas Cap.....\$30
- 65/66 "289" Fender badge.....\$7
- 65/66 RH or LH Running horse badge\$7
- 65/66 chrome hood lip moulding\$8
- 65-67 "GT" fender badge.....\$7
- 65/66 Shelby Racing mirror\$75
- 65/66 Rare Remote control mirror\$45
- 65/66 RH or LH front bumper guard.....\$8
- 67/68 Complete Heater/Defroster System\$50

Literature, Tags & Decals

Vivid, Red, White & Blue License Plate or wall plaque crafted from 32 gauge aluminum features running mustang and ford oval underscored with bold block letters\$3

Original Full-Color 65 owner's manual \$10

NEW! NEW! 65 MUSTANG OWNER PACKET

INCLUDES: original owner's manual, All 6 replacement decals, full color window sticker and factory pricing information, 8 page Mustang history, red, white and blue license plate or wall plaque and smart avon decantor of first mustang

\$25⁰⁰

NOTICE: WE DO NOT PUBLISH A PARTS LIST, BUT WILL GLADLY HELP YOU LOCATE YOUR PART.

USED

- 65 up convertible top motor...excellent\$10
- 65 standard wheel covers...excellent\$7
- 66 standard wheel covers...excellent\$7
- 67 standard wheel covers...excellent\$7
- 68 standard wheel covers...excellent\$7
- 66 complete grill & pony assem...excellent\$50
- 65/66 walnut steering wheel (No Hardware).....\$50
- 65/66 chrome trimmed foot pedals . . excellent..\$10
- 65/66 convertible boot, red, good, no tears.....\$30
- 65/66 convertible boot, white, good, no tears\$30
- 65/66 chrome full console shift plate (auto).....\$10
- 65/66 Pony interior door light assembly,.....\$15 pr
- 65/66 AM Radio...excellent.....\$15
- 66 gas cap...excellent.....\$8
- 70 gas cap...excellent.....\$8
- 67/68 chrome remote mirror...excellent\$10
- 65/66 chrome remote mirror...excellent\$18
- 65/66 outside standard mirror ...excellent\$10
- 65 up original jack & lug tool ratchet excellent ...\$20
- 65/66 vinyl top chrome trim set...excellent\$25
- 65/66 "289" fender badge...excellent.....\$3
- 65/66 "Running horse" fender badge...excellent . \$3
- M-U-S-T-A-N-G letters for G.T. fender...excellent ..\$1
- 65/66 F-O-R-D hood letters...excellent.....\$2
- 65/66 chrome tail light bezel...excellent\$4
- 65 "260" fender badge...excellent\$3
- 67 horse, corral & bars for grill...excellent\$20
- 65/66 convertible well exterior chrome.excellent\$25

MUSTANG SUPPLY CO.

Bx 5917 LAKELAND
FLORIDA 33803

Phone 1-813-644-2300
6 p.m. til 10 p.m. E.S.T.
ALL DAY WEEKENDS

classified advertising

-----MUSTANG PARTS AT DISCOUNT-----

Genuine fresh new Ford stock. Prices shown have had 20% deducted from list prices. We pay freight. Add \$2.50 per order for packing. BUMPERS 65-70 front & rear \$46.32 ea. SHEET METAL, 65-68 front fenders \$78.96 ea. 69-70 front fenders \$80.16 ea. 65-66 rear quarters (F63) \$101.12 ea. (F65, F76) \$86.32 ea. 1967 rear quarters (F63) \$101.12 ea. (F65) \$86.32 ea. 1965-70 panel, inner wheelhouse \$25.12 ea. 1965-68 panel, outer wheelhouse \$25.12 ea. RUBBER DASH PADS, 1965 Black, blue, red \$69.56 ea. 1966 Black, blue, burgundy \$69.56 ea. 69-70 Black only \$100.00 ea. ALL MUSTANG PARTS THAT WE CAN SECURE FROM FORD DISCOUNTED 20% FROM LIST PRICE, PLUS \$2.50 PER ORDER PACKING CHARGE, PREPAID. SEND US YOUR LIST WITH COMPLETE PART NUMBERS FOR QUOTE, SEND S.A.S.E. OR NO ANSWER, WE CAN SUPPLY PART BOOKS IF YOU DON'T HAVE A SET. WE SUGGEST YOU BUY YOUR MUSTANG PART REQUIREMENTS WHILE YOU CAN STILL GET THEM. BIRD Sheet metal, we can supply at 20% off list price. We will supply any parts that FORD has in stock 1948 through 1977 20% off list price, HAVE TO HAVE COMPLETE PART NUMBERS WITH S.A.S.E. FOR QUOTE.....

"A FORD DEALER COLLECTOR"

BOB COOK, P.O. BOX # 104, HAZEL, KY. 42049

Trade-Trade: '73 Mustang convertible 302, 4 cyl V-8, Auto, A/C, P.S., P.B. Red w/new white top. Rust free. 64,000 miles. Beautiful parade car. Shrine car. Looking for mint or excellent '65 or '66 G.T. 289 coupe or convertible. Pictures and conditions of trade and further info: Larry Dobbs, 4532 Remington Rd., Lakeland, Fl. 33803 (813) 644-2300 evenings before 11 p.m. EST.

For Sale: Now In Stock: 65-66 "Pony" floor mats. Black, white, blue, green, brown, also white and burgundy for Cougar. Will ship prepaid @ \$45/set of four. Jim Bridges, 321 Melrose Circle, Lenoir, N. C. 28645 (704) 728-6021.

For Sale: 65 6,000 RPM Rally-Pac in good working condition \$125 + \$5 shipping. Larry Dobbs, 4532 Remington Rd., Lakeland, Fl. 33803.

For Sale: 200 cu. in. 6 air cleaner decals, \$1.00 each. Jim Osborn's, 3229 Pheasant Drive, Marietta, Ga. 30034.

For Sale: (1) original 65 all chrome C.T. wheel in good condition w/new center cap \$40 + \$5 shipping. Larry Dobs, 4532 Remington Rd., Lakeland, Fl. 33803

For Sale: 1965 Mustang Convertible, 289, Auto A/C, P.S., console, wire spinners, impeccable original misty green exterior with green and white interior. Everthing is mint concours condition, \$4000 David Zaun, 21 Kenwood Dr., Dunedin, Fla. (813) 733-3224

For Sale: 1967/68 Wire wheel covers w/red center in excellent condition \$80 or will trade for pair of pony interior door panels (no cracks or tears) or trade for 65 or 66 Rally-Pac or Larry Dobbs, 4532 Remington Rd., Lakeland, Fl. 33803 Phone (813) 644-2300

For Sale: Used 66 Mustang Fastback Hood \$25.00 Folding Rear seat assy. Grille, Door Panels, Inst, cluster, trim pieces, glove box door. Allen Bruehahn, Vandebilt Ave. So. Norwalk, Conn. 06854 853-7893

Wanted: Blue boot cover and left and right kick panels for a 1966 Mustang convertible. Gary Jones, Box 887, Clayton, Ga. 30525 (404) 782-4016 or (404) 754-9431

November Special: NOS original Mustang parts Save on prices and shipping. 65-70 bumpers (4) limited qty. original "pony" mats black, white, blue, green, brown, 45/set of four; 65-66 trunk mats, 21; 65-66 GT exhaust trumpets, 50; 66 gas caps, 25; 65-66 battery box w/hold-down 8; 65 grille, 20; 66 grille, 30; 65-66 black steering wheel, 40; 67-73 door edge guard, 15; 65-6665-66 key blanks, 5/pr; 65-66 inside door lock grommets, 1/pr; chrome plate behind 65-66 deluxe inside door handles, 5/pr.; 65-67 antennas, 26; 65-66 speedometer housings, black or woodgrain, 16. I will ship above by UPS prepaid. Much more--emblems, ornaments, decal etc. Jim Bridges, 321 Melrose Circle, Lenoir, N.C. 28645 (704) 728-6021.

For Sale: 1965/66 Factory air conditioning system, complete w/compressor, condensor, evaporator, pressure hoses, under dash unit and all attaching parts. \$150.00. George Leach, 2116 S. Hesperides, Tampa, Fl. (813)254-6871.

Wanted: '65, '66 or '67 Mustang convertible. 3 or 4 speed. At least running. Will take automatic if cheap. Prefer 6 cylinder. Steven Dix, Box 905, Route 6, Manchester, Tn. 37355

For Sale: Chrome for full console, less ash tray and compartment door (has automatic trans. plate) excellent condition \$20 + \$3 shipping. Larry Dobbs, 4532 Remington Rd., Lakeland, Fl. 33803

classified advertising

For Sale: 68-69 NOS chrome rally factory mag wheels w/new trim rings and GT caps. Priced low at \$250/per set complete. Also 4 nice used wheels as above with two trim rings and caps, \$125/set. Don't wait until these hit \$100 each as the 65-66 wheels have done. Please add \$15/set for UPS. Jim Bridges, 321 Melrose Cir., Lenoir, N.C. 28645 (704) 728-6021.

For Sale: 2-13" wheel covers for 65 Mustang with 3-prong spinner in good condition \$12 ea. 14" wheel cover for 65 Mustang w/3-prong spinner \$15 - add \$3 shipping charge. Larry Dobbs 4532 Remington Rd., Lakeland, Fl. 33803

For Sale: NOS '67 woodgrain steering wheel and NOS right side mirror for 1966 Mustang. Larry Hughes, 1522 E. Washington St., Washington, Iowa 52353

For Sale: 65/66 Beige "Pony" interior set of door panels. These are torn around hand grip area and need repair. Otherwise O.K. w/good chrome trim. \$40/pr + \$5 shipping. Larry Dobbs, 4532 Remington Rd., Lakeland, Fl. 33803

For Sale: 65-66 chrome and black finish panel or short, air cond. console, \$25; original pony key blanks, \$5/pr.; regular tissue dispenser, \$15; junior-size, 10. Outside door handles, 15/pr; 65-67 antennas, 25; new 65-66 AM radio kit complete, \$75, radio only, \$50. Jim Bridges, 321 Melrose Cir., Lenoir, N.C. 28645 (704) 728-6021.

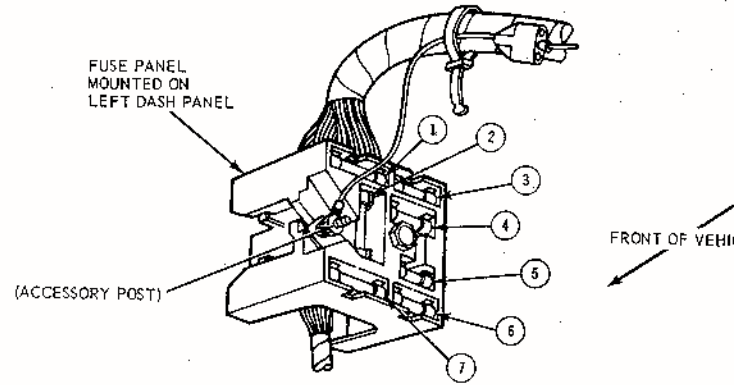

- ① (20 AMP.) TURN SIGNALS, BACK-UP LIGHTS, WINDSHIELD WASHER, RADIO FEED AND PRNDL LIGHT(AUTO. TRANS.)
- ② (20 AMP.) (ACCESSORY FEED) SEAT BELT WARNING (RPO), SWING TILT COLUMN (RPO) SAFETY CONVENIENCE CIRCUIT-DOOR AJAR, LOW FUEL, POWER WINDOW SAFETY RELAY FEED
- ③ (14 AMP.) HEATER & DEFROSTER (30 AMP.) AIR CONDITIONER NOTE: (30 AMP. REQUIRED FOR AIR/COND.)
- ④ (SPARE)
- ⑤ (4 AMP.) INSTRUMENT & CLUSTER LIGHTS, RADIO, HEATER CONTROLS, CLOCK, ASH TRAY LIGHT
- ⑥ (14 AMP.) COURTESY, INSTRUMENT, DOOR, DOME, MAP, GLOVE BOX, "C" PILLAR, LUGGAGE COMPARTMENT LIGHT, CLOCK FEED, CIGAR LIGHTER
- ⑦ (20 AMP.) EMERGENCY WARNING

FUSE PANEL-MUSTANG 1969/70

MUSTANG TIMES BACK ISSUES

AUGUST 1977	\$1.00
SEPTEMBER 1977	1.00
OCTOBER 1977	1.00

SECOND ANNUAL All Ford Swap Meet

INDOOR FLEA MARKET

RESTRICTED TO PARTS & CARS MADE BY FORD

January 13 and 14, 1978

Nashville, Georgia

Sponsored By Ford, Inc. Nashville, Georgia 31639

ENDORSED BY NASHVILLE CHAMBER OF COMMERCE

FORD - MERCURY

REGIONAL GROUP NEWS

GEORGIA REGIONAL GROUP

ur drive to the Mountains was a grand success. e departed from Perimeter Mall at 9:30 a.m. he group was composed of a variety of Mustangs. fter a few hours, our convoy arrived at nicoi State Part. Upon arrival we met ames Kinney and his family and the Bill Hat- fields. We then proceeded to an alternate estination for our picnic at which time we ade plans for our Christmas Banquet.

le were accompanied by a cool breeze and mild recipitation. After eating, we toured Helen, eorgia and went our separate ways back home.

FIRST TENNESSEE REGIONAL GROUP, INC.

minutes of October 27, 1977 monthly meeting:

A Christmas Banquet at Country House in Bristol was discussed. This will be on December 10.

New members were informed that silk screening can be done at no charge and to see Don Wolfe for this. Club jackets have not been located yet but several sources are being checked for prices and quality.

The Eastern National Show was discussed. Don Wolfe read the contractual agreement between Fort Henry Mall and our club. The date for this Show will be May 26, 27 and 28. A sample second-place trophy was shown. Each member was asked to get busy immediately and sell one trophy at \$20. Merchants buying trophies will receive recognition in the form of advertisements and acknowledgements in the local paper as well as at the show site.

Ramada Inn will be our show headquarters and the banquet will also be held there. 100 rooms have been set aside for show members and will be reserved on a first-come basis. Ramada Inn will donate 3 trophies to the show and provide transportation between the Inn and the Mall. A large banner to be used for the Car Show was displayed. This banner was made by Marshall Spears.

Our November meeting will be the 4th Tuesday at 7 p.m. Eight Board of Directors will be elected. A motion was made and seconded to adopt the National By-Laws as written without modification. Our December meeting will be held on December 10 in conjunction with our Christmas Banquet.

A local show will be held February 23 thru 26 at the Fort Henry Mall and our club will be paid \$250.

Membership now totals 65. New members present were Clara Lee Hunt, Randy Morley, Melvin Wall Randy Greer and Jeffrey Jenkins. Max told members he has decals available for those restoring cars.

Charles Carey is working to obtain a guest speaker from Ford Motor Company in Detroit for the National Banquet. Hopefully he will be able to have someone who helped in the development of the Mustang. We now must begin securing judges for the National Show.

The Board of Directors were given a vote of confidence for the work on the National Show performed to date.

Betty Cox, Secretary

FLORIDA REGIONAL GROUP

The Florida Regional Group of The Mustang Club of America held its first meeting, Saturday, October 22 in Lakeland. A day of drizzling rain and high winds failed to dampen the spirit of some 50-60 enthusiasts who came from as far as 100 miles to sign up for the club or offer support for the first meet.

The following members joined the Florida Regic A. Jack & Jackie Gooch, Orlando; Bill Cornelius of St. Petersburg; Bill & Janice Butler, Large Jim & Arline Gage, Sarasota; Larry & Judy Dobb Lakeland.

The following are new National and Regional members, and we extend a special welcome to them into America's greatest and fastest growing auto club: J. Gordon & Mercedes Smith, Avon Park; R. James & Mary Robbins, Tampa; Andy & Joan Alach, Lakeland; Jack Mallory, Avon Park and Al & Kay Forand, St. Petersburg. This gives our new group a total of 10 members with the expectation of many more.

The Club sincerely appreciates everyone who came out. Our next order of business will be the appointment of a Regional Board of Directors and the election of officers.

Anyone interested in joining our group should contact: Larry Dobbs
4532 Remington Road
Lakeland, Florida 33803
(813) 644-2300 evenings.

Larry & Judy Dobbs
and 22 more!

... OUR ADVERTISERS ... SUPPORT THEM !



CLASSIC INSURANCE AGENCY

Hoke S. Rawlins
Residence: 435-3588

639 LINDBERGH WAY, N.E.
ATLANTA, GEORGIA 30324
404 262-2264

AUTOMOTIVE



MARINE

Specializing in Parts For All Ford Products

Total Performance

J & E
RACING
ENGINES

SALES

SERVICE

Call (313) 468-FORD

40631 Irwin Mt. Clemens, Mich. 48045

JOHN VERMEERSCH

KEN MOE

SPECIAL INTEREST CARS

P. O. Box 2088

Westminster, California 92683



65-73 MUSTANG 69-70 "BOSS"

PARTS

Phone (714) 897-3335



404-241-5158

JIM OSBORN

AUTOMOBILE LITERATURE

3229 PHEASANT DR.
DECATUR, GEORGIA 30034



JACK R. SHOOK
OWNER

9 A.M.-6 P.M.
MON.-SAT.

SHOOK AUTO SUPPLY

8529 S. BRAESWOOD
HOUSTON, TEXAS 77071
(713) 772-0281

PARTS AND ACCESSORIES

GT 350 ■ MUSTANG ■ GT 500

ATLANTA AUTO
Classics

APPRECIATING AUTOS

2881 BUFORD HWY
ATLANTA, GA 30329

PH. 404-325-2333

GREG MILLS

STONE MOUNTAIN



NEW & USED CARS & TRUCKS

SALES-SERVICE

LEE GREENFIELD

SALES REPRESENTATIVE

STONE MOUNTAIN FORD

6121 MEMORIAL DRIVE

STONE MOUNTAIN, GA 30083

469-3131

LICENSE PLATES

POST CARDS

PICTURES

CARLTON L. CHEWNING

AUTOMOBILE COLLECTABLES

1520 S. HAIRSTON RD.
STONE MOUNTAIN, GA. 30088

404 - 981-1933

NOS MUSTANG PARTS

Specializing in new-obsolete parts
"Fair prices--Good Service"

JIM BRIDGES
321 MELROSE CIR.
LENOIR, N. C. 28645
704-728-6021



P. O. Box 5917 - Lakeland, Florida 33803
Phone 813 - 644-2300

NEW and USED PARTS and ACCESSORIES
We specialize in 65-67 new and used parts
Both Buy and Sell

GARY GODDARD'S

MUSTANG PARTS
NOS AND USED
BOX 5 BOX 550
COVINGTON, GA. 30209
404-787-3793

SEND LARGE S.A.S.E. FOR FREE
SIX PAGE PARTS LIST..

ATLANTA AUTO
Classics

APPRECIATING AUTOS

2881 BUFORD HWY
ATLANTA GA 30329

PH 404 325 2333

J HENLY MAGEE, VICE PRES



... OUR ADVERTISERS ...

SUPPORT THEM !

California Auto Sales

MUSTANGS Only

SEDANS - CONVERTIBLES

5863 Washington Boulevard
Culver City, California 90230

938-0191

NATIONAL PARTS DEPOT

AREA (904) 377-BIRD
2908 S.W. 4TH COURT
GAINESVILLE, FLORIDA 32601



MUSTANG **SHELBY**



BRENT DANNEMAN
EARLY MUSTANG CARS & PARTS

85 DALRYMPLE RD.
ATLANTA, GA. 30328

(404) 393-3040
(404) 688-9520

THE ORIGINAL
OBSOLETE FORD PARTS CO.
NEW, GENUINE FORD-MUSTANG PARTS
NASHVILLE, GA. 31639
(912)-686-2470
Ford Parts Specialists
since 1950

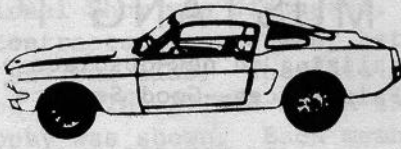

TONY D. BRANDA
MUSTANG AND SHELBY PARTS
703 GRANT AVENUE
ALTOONA, PA. 16602—Phone (814) 942-1869

We Specialize in the Detailing and the Finishing Touch

ATLANTA AUTO Classics

APPRECIATING AUTOS

2881 BUFORD HWY
ATLANTA GA 30329

PH 404 325 2333

CHARLES R LANE, PRES.



MUSTANG TIMES

The Official Newsletter of the

THE MUSTANG CLUB OF AMERICA, INC.
P. O. BOX 447
LITHONIA, GEORGIA 30058

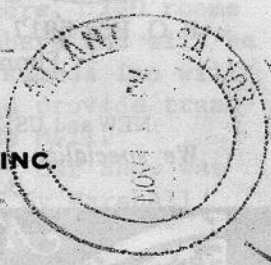

FIRST CLASS MAIL

